

# #weldinglikeaPRO



## GPPH PRODUCTS OFFER

GET THE ADVANTAGE  
OF GPPH PRODUCTS  
BY MAKING PRECISE  
CONSTRUCTIONS IN  
A MUCH SHORTER TIME!



BY GPPH | 06.2022

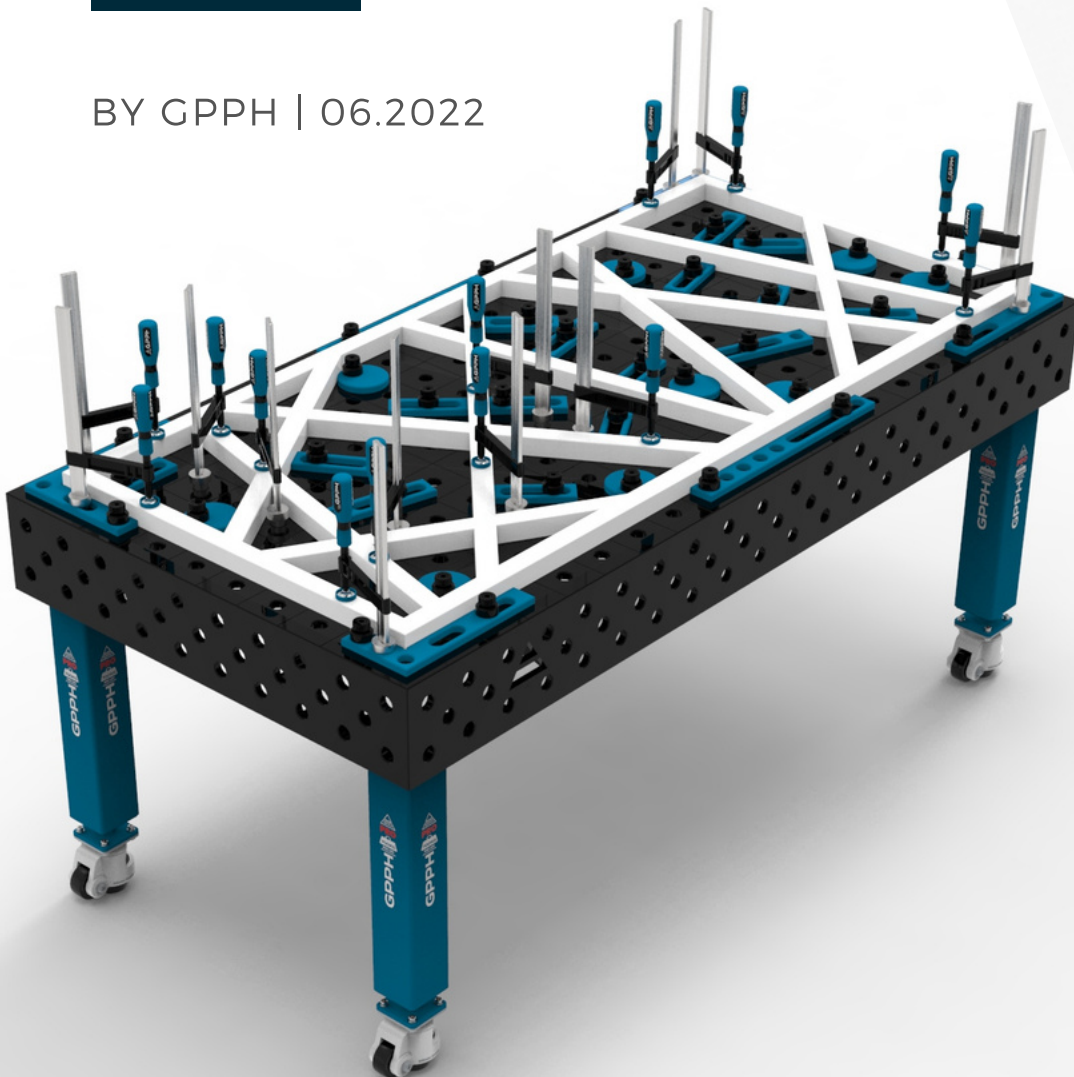

We think outside the box, and the results are easily seen in our creative solutions. We believe that everything we do challenges the "status quo." We change the world by helping other companies to become stronger. It just so happens that we produce excellent welding tools, which are not only user-friendly but also beautifully designed. Our mutual respect and pursuit of the highest goals result in cooperation with the best specialists in the industry around the world.

## PROFESSIONAL APPROACH TO PRECISION WELDING

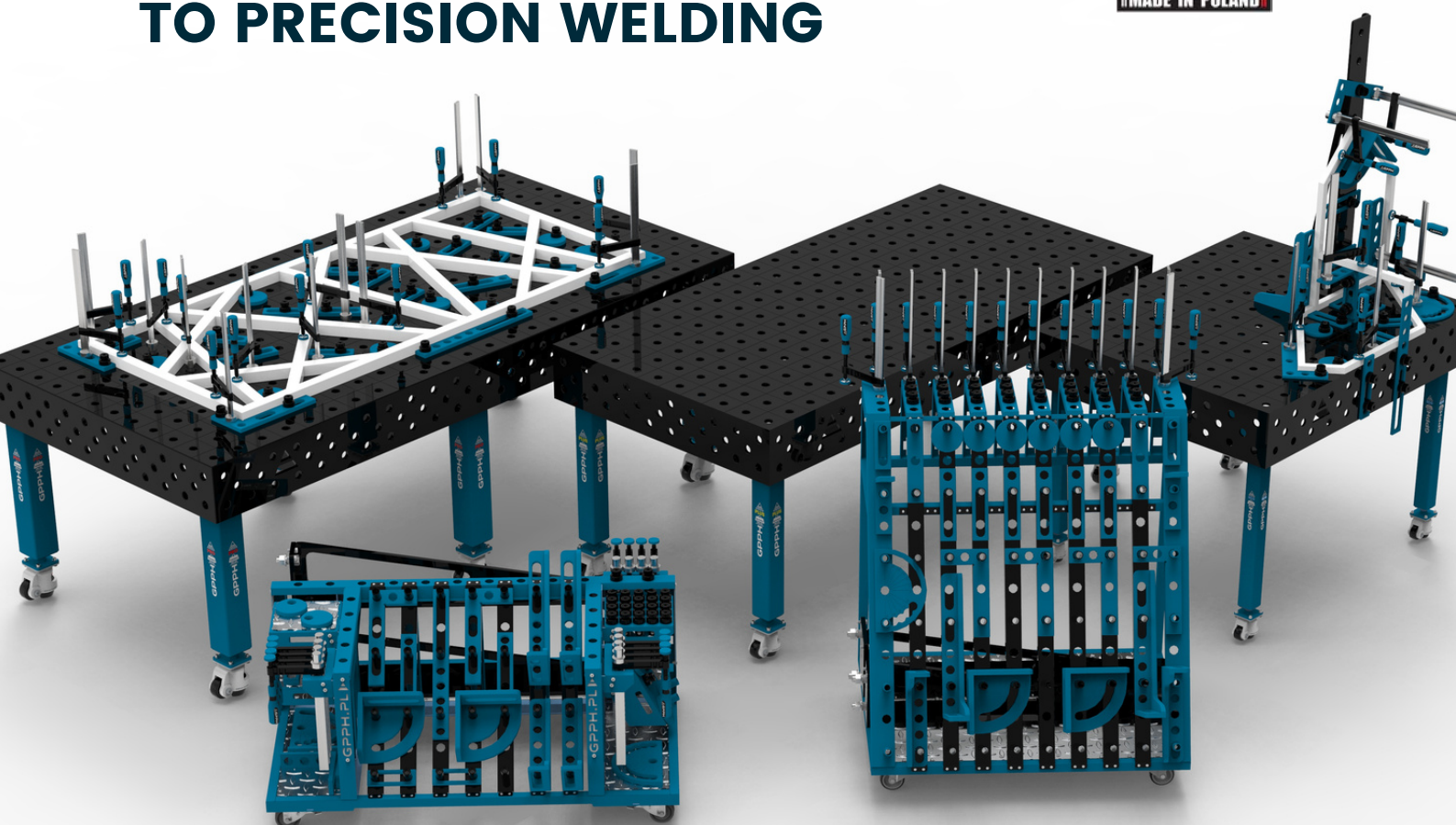

# TABLE OF CONTENTS

1. Traditional Welding Tables PRO	5
◦ Technical parameters	6
◦ Dimensions of Traditional Welding Tables PRO	7
2. Traditional Welding Tables PLUS	12
◦ Technical parameters	13
◦ Dimensions of Traditional Welding Tables PLUS	14
3. Traditional Welding Tables ECO	19
◦ Technical parameters	20
◦ Dimensions of Traditional Welding Tables ECO	21
4. Greater mobility of the GPPH Welding Table - Legs on a wheel!	26
5. Stainless steel covers for GPPH Traditional Welding Tables	27
6. Assembly-welding Table DIY	28
◦ Technical parameters	29
◦ Applications of the Assembly-Welding Table DIY	31
◦ Additional equipment for DIY Welding Tables	33
7. Modular Welding Tables GPPH	34
◦ Technical parameters	36
◦ Advantages and benefits of Modular Tables	38
◦ Non-nitrided Modular Welding Tables	39
◦ Nitrided Modular Welding Tables	41
◦ Additional equipment for Modular Welding Tables	43
8. Grinding-welding station	44
◦ Technical parameters	45
◦ Grinding-welding station - base	46
◦ Grinding-welding station - base with guards	47
◦ Grinding-welding station - base with top exhaust	48
9. Additional equipment for GPPH Welding Tables	49
◦ Accessories from the PRO series	50
◦ Accessories from the PLUS series	54
◦ Accessories from the ECO series	58
◦ Fastening clamps	60
◦ Prisms, Welding torch handle, toolshelves	61
◦ Toolshelves	62
10. Toolkit proposal for GPPH Welding Tables	63
◦ Toolkits PRO	64
◦ Toolkits PLUS	68
11. Order does metter - GPPH Tool Trolley	72

# WORK SMARTER, NOT HARDER

WELDING TABLE PROVIDES FAST AND ERROR-FREE OPTIONS FOR MACHINING A SIMPLE 2D-CONSTRUCTION (E.G. BUILDING OF RAILINGS), BUT ABOVE ALL, PRECISE WORK ON OBJECTS WITH A LARGER NUMBER OF DIMENSIONS.

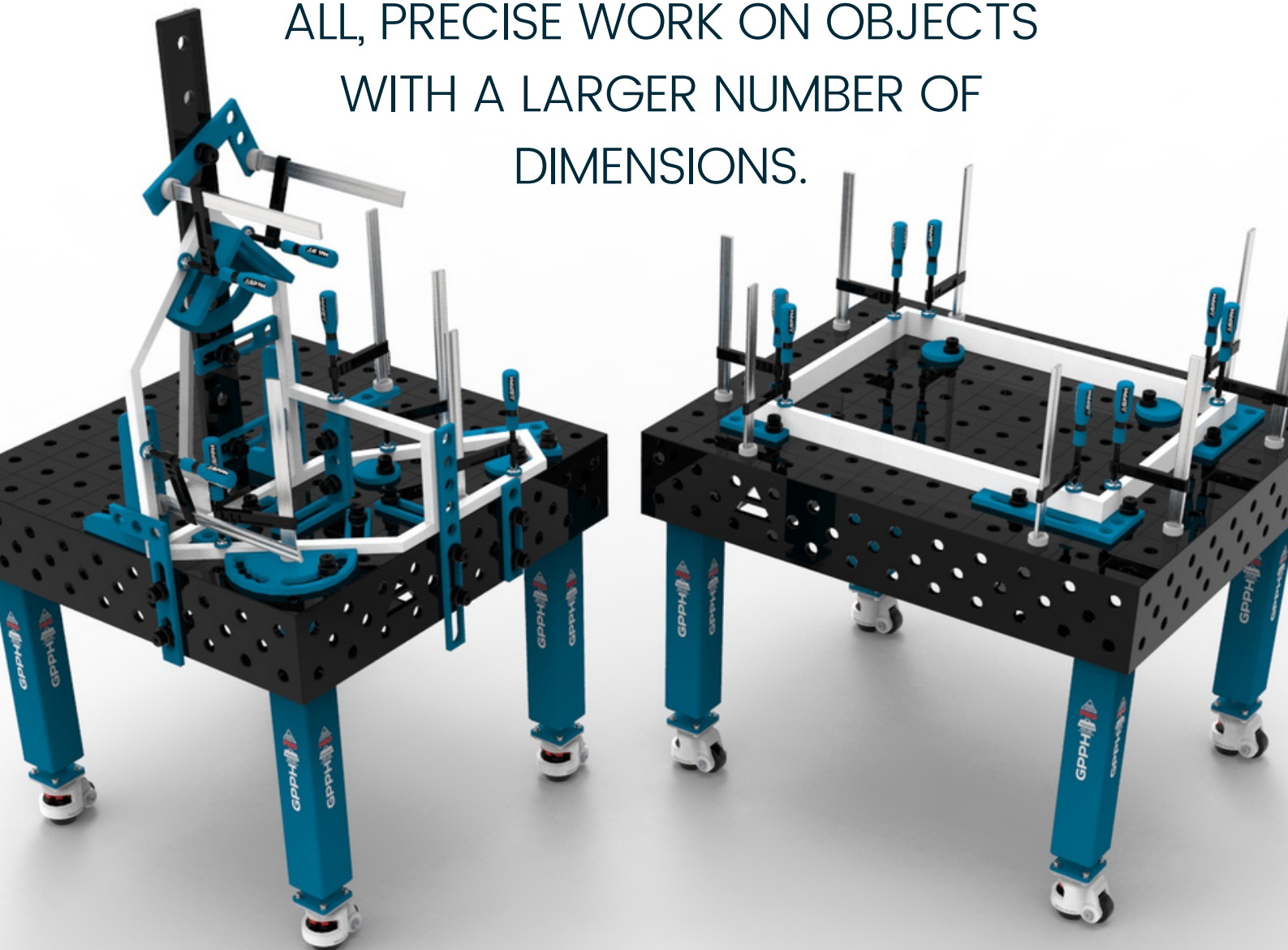

# TRADITIONAL WELDING TABLES **PRO**

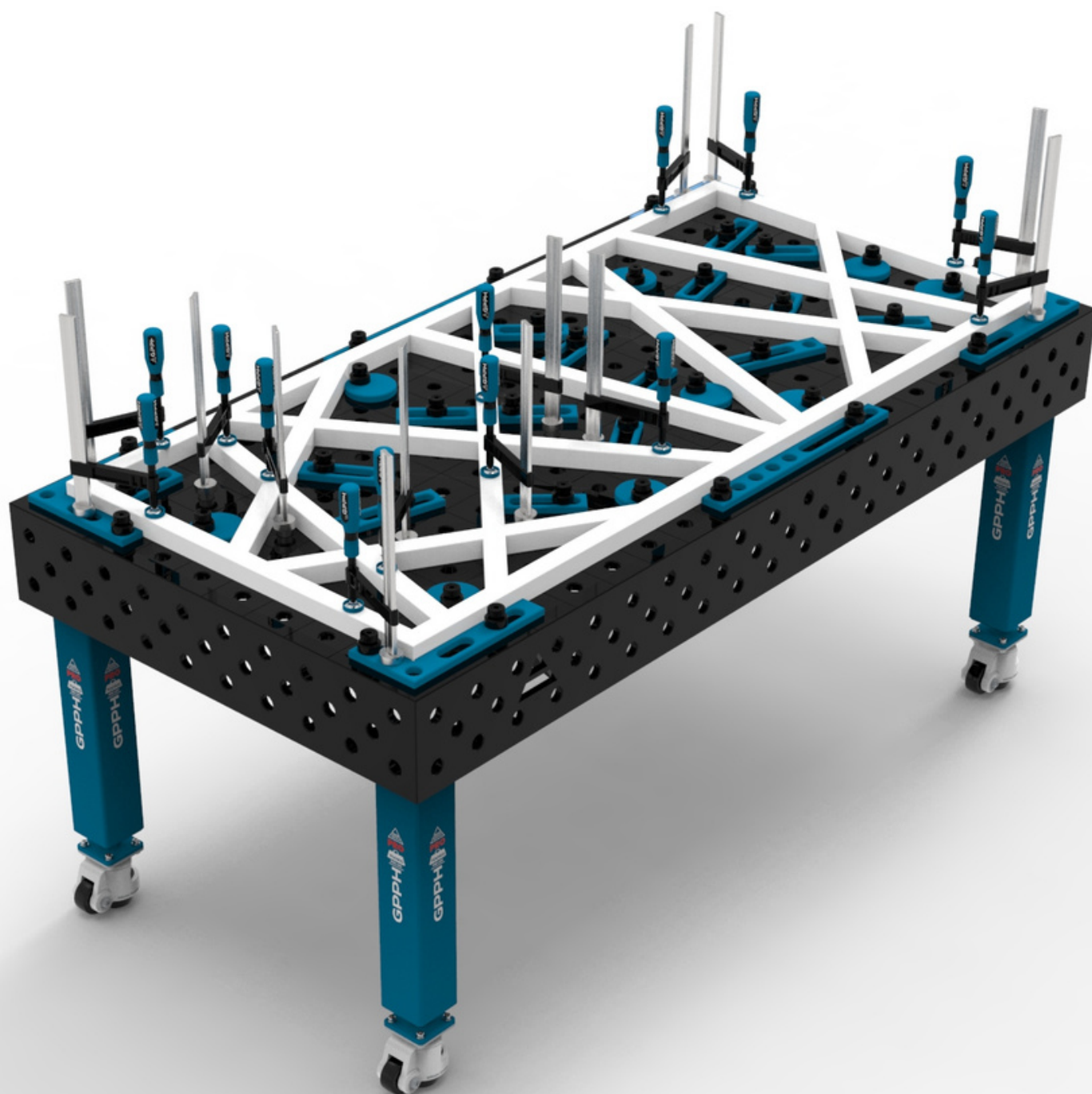

# TECHNICAL PARAMETERS

---

- ✓ Stable and massive construction
- ✓ The highest quality of workmanship
- ✓ Perfect flatness of the table [ + / - 0,5mm ]
- ✓ Made of S355J2+N
- ✓ Holes of system  $\varnothing 16$  in the grid 50x50mm or 100x100mm or holes of system  $\varnothing 28$  in the grid 100x100mm
- ✓ Three grids of holes on the 4 sides
- ✓ Chamfered and milled holes for easy tool assembly
- ✓ Engraved scale in the grid 100x100mm
- ✓ Height adjustment of the table with standard legs approx. 880-930mm
- ✓ Possibility of using stainless steel covers
- ✓ Tables can be combined freely to extend a working surface
- ✓ All tables are reinforced with ribs
- ✓ Produced with standard ISO 2768-1
- ✓ Milled worktop edges
  - Thickness **15mm**
  - Table legs made of profile **100x100mm**
  - Capacity: **700kg/leg\***

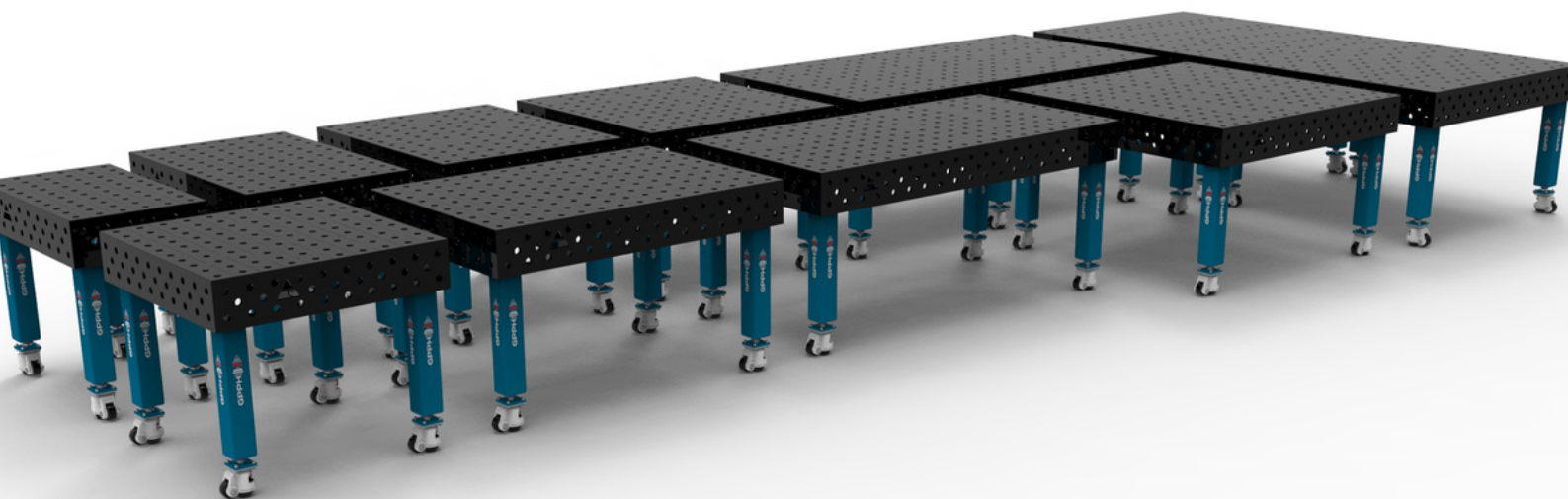

\*Applies to standard legs on the foot. When it comes to legs on wheels, it is the static load capacity - it refers to the situation where the table is supported on the feet protruding from the wheels.

# DIMENSIONS OF TRADITIONAL WELDING TABLES<sup>PRO</sup>

---

## GPPH TRDITIONAL WELDING TABLE<sup>PRO</sup> TWT.PRO.300148

---



- length x width: 3000x1480mm
- side plate: 200mm
- table weight: approx. 980 kg
- capacity: 5 600 kg
- number of legs: 8

\* The 3000x1480 GPPH welding table consists of two 1500x1480 GPPH welding tables connected to each other.

## GPPH TRDITIONAL WELDING TABLE<sup>PRO</sup> TWT.PRO.240120

---



- length x width: 2400x1200mm
- side plate: 200mm
- table weight: approx. 630 kg
- capacity: 4 200 kg
- number of legs: 6

# DIMENSIONS OF TRADITIONAL WELDING TABLES<sup>PRO</sup>

---

## GPPH TRDITIONAL WELDING TABLE<sup>PRO</sup> TWT.PRO.200100

---



- length x width: 2000x1000mm
- side plate: 200mm
- table weight: approx. 460 kg
- capacity: 2 800 kg
- number of legs: 4

## GPPH TRDITIONAL WELDING TABLE<sup>PRO</sup> TWT.PRO.150148

---



- length x width: 1500x1480mm
- side plate: 200mm
- table weight: approx. 460 kg
- capacity: 2 800 kg
- number of legs: 4



# DIMENSIONS OF TRADITIONAL WELDING TABLES<sup>PRO</sup>

---

## GPPH TRDITIONAL WELDING TABLE<sup>PRO</sup> TWT.PRO.150100

---



- length x width: 1500x1000mm
- side plate: 200mm
- table weight: approx. 370 kg
- capacity: 2 800 kg
- number of legs: 4

## GPPH TRDITIONAL WELDING TABLE<sup>PRO</sup> TWT.PRO.120120

---



- length x width: 1200x1200mm
- side plate: 200mm
- table weight: approx. 350 kg
- capacity: 2 800 kg
- number of legs: 4

# DIMENSIONS OF TRADITIONAL WELDING TABLES<sup>PRO</sup>

---

## GPPH TRDITIONAL WELDING TABLE<sup>PRO</sup> TWT.PRO.120100

---



- length x width: 1200x1000mm
- side plate: 200mm
- table weight: approx. 320 kg
- capacity: 2 800 kg
- number of legs: 4

## GPPH TRDITIONAL WELDING TABLE<sup>PRO</sup> TWT.PRO.12080

---



- length x width: 1200x800mm
- side plate: 200mm
- table weight: approx. 270 kg
- capacity: 2 800 kg
- number of legs: 4

# DIMENSIONS OF TRADITIONAL WELDING TABLES<sup>PRO</sup>

---

## GPPH TRDITIONAL WELDING TABLE<sup>PRO</sup> TWT.PRO.100100

---



- length x width: 1000x1000mm
- side plate: 200mm
- table weight: approx. 280 kg
- capacity: 2 800 kg
- number of legs: 4

## GPPH TRDITIONAL WELDING TABLE<sup>PRO</sup> TWT.PRO.10060

---



- length x width: 1000x600mm
- side plate: 200mm
- table weight: approx. 210 kg
- capacity: 2 800 kg
- number of legs: 4

# TRADITIONAL WELDING TABLES **PLUS**

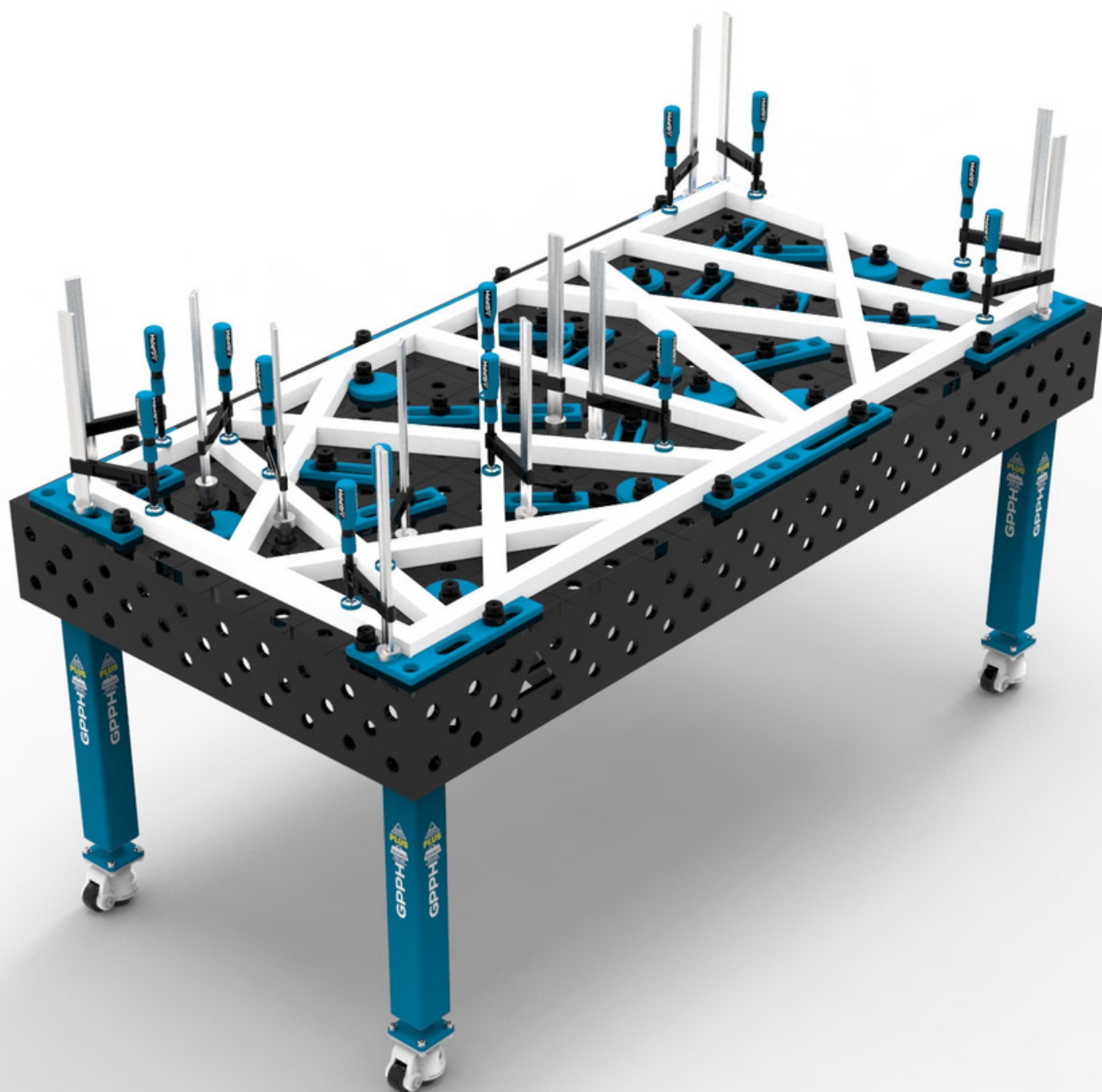

# TECHNICAL PARAMETERS

---

- ✓ StStable and massive construction
- ✓ The highest quality of workmanship
- ✓ Perfect flatness of the table [ + / - 0,5mm ]
- ✓ Made of S355J2+N
- ✓ Holes of system  $\varnothing 16$  in the grid 50x50mm or 100x100mm or holes of system  $\varnothing 28$  in the grid 100x100mm
- ✓ Three grids of holes on the 4 sides
- ✓ Chamfered and milled holes for easy tool assembly
- ✓ Engraved scale in the grid 100x100mm
- ✓ Height adjustment of the table with standard legs approx. 880-930mm
- ✓ Possibility of using stainless steel covers
- ✓ Tables can be combined freely to extend a working surface
- ✓ All tables are reinforced with ribs
- ✓ Produced with standard ISO 2768-1
- ✓ Milled worktop edges
- Thickness **12mm**
- Table legs made of profile **80x80mm**
- Capacity: **500kg/leg\***

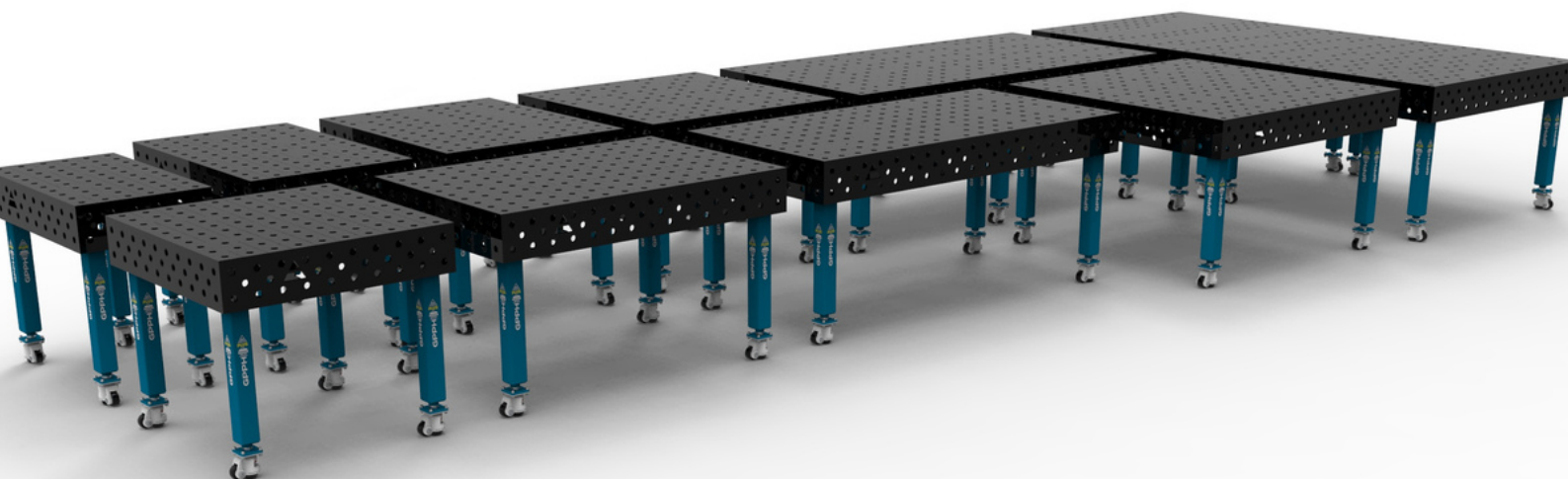

\*Applies to standard legs on the foot. When it comes to legs on wheels, it is the static load capacity - it refers to the situation where the table is supported on the feet protruding from the wheels.

# DIMENSIONS OF TRADITIONAL WELDING TABLES<sup>PLUS</sup>

## GPPH TRDITIONAL WELDING TABLE<sup>PLUS</sup> TWT.PLUS.300148



- length x width: 3000x1480mm
- side plate: 200mm
- table weight: approx. 780 kg
- capacity: 4 000 kg
- number of legs: 8

\* The 3000x1480 GPPH welding table consists of two 1500x1480 GPPH welding tables connected to each other.

## GPPH TRDITIONAL WELDING TABLE<sup>PLUS</sup> TWT.PLUS.240120



- length x width: 2400x1200mm
- side plate: 200mm
- table weight: approx. 510 kg
- capacity: 3 000 kg
- number of legs: 6

# DIMENSIONS OF TRADITIONAL WELDING TABLES<sup>PLUS</sup>

---

## GPPH TRDITIONAL WELDING TABLE<sup>PLUS</sup> TWT.PLUS.200100

---



- length x width: 2000x1000mm
- side plate: 200mm
- table weight: approx. 370 kg
- capacity: 2 000 kg
- number of legs: 4

## GPPH TRDITIONAL WELDING TABLE<sup>PLUS</sup> TWT.PLUS.150148

---



- length x width: 1500x1480mm
- side plate: 200mm
- table weight: approx. 390 kg
- capacity: 2 000 kg
- number of legs: 4

# DIMENSIONS OF TRADITIONAL WELDING TABLES<sup>PLUS</sup>

---

## GPPH TRDITIONAL WELDING TABLE<sup>PLUS</sup> TWT.PLUS.150100

---



- length x width: 1500x1000mm
- side plate: 200mm
- table weight: approx. 300 kg
- capacity: 2 000 kg
- number of legs: 4

## GPPH TRDITIONAL WELDING TABLE<sup>PLUS</sup> TWT.PLUS.120120

---



- length x width: 1200x1200mm
- side plate: 200mm
- table weight: approx. 280 kg
- capacity: 2 000 kg
- number of legs: 4



# DIMENSIONS OF TRADITIONAL WELDING TABLES<sup>PLUS</sup>

---

## GPPH TRDITIONAL WELDING TABLE<sup>PLUS</sup> TWT.PLUS.120100

---



- length x width: 1200x1000mm
- side plate: 200mm
- table weight: approx. 260 kg
- capacity: 2 000 kg
- number of legs: 4

## GPPH TRDITIONAL WELDING TABLE<sup>PLUS</sup> TWT.PLUS.12080

---



- length x width: 1200x800mm
- side plate: 200mm
- table weight: approx. 220 kg
- capacity: 2 000 kg
- number of legs: 4

# DIMENSIONS OF TRADITIONAL WELDING TABLES<sup>PLUS</sup>

---

## GPPH TRDITIONAL WELDING TABLE<sup>PLUS</sup> TWT.PLUS.100100

---



- length x width: 1000x1000mm
- side plate: 200mm
- table weight: approx. 230 kg
- capacity: 2 000 kg
- number of legs: 4

## GPPH TRDITIONAL WELDING TABLE<sup>PLUS</sup> TWT.PLUS.10060

---



- length x width: 1000x600mm
- side plate: 200mm
- table weight: approx. 170 kg
- capacity: 2 000 kg
- number of legs: 4

# TRADITIONAL WELDING TABLES **ECO**

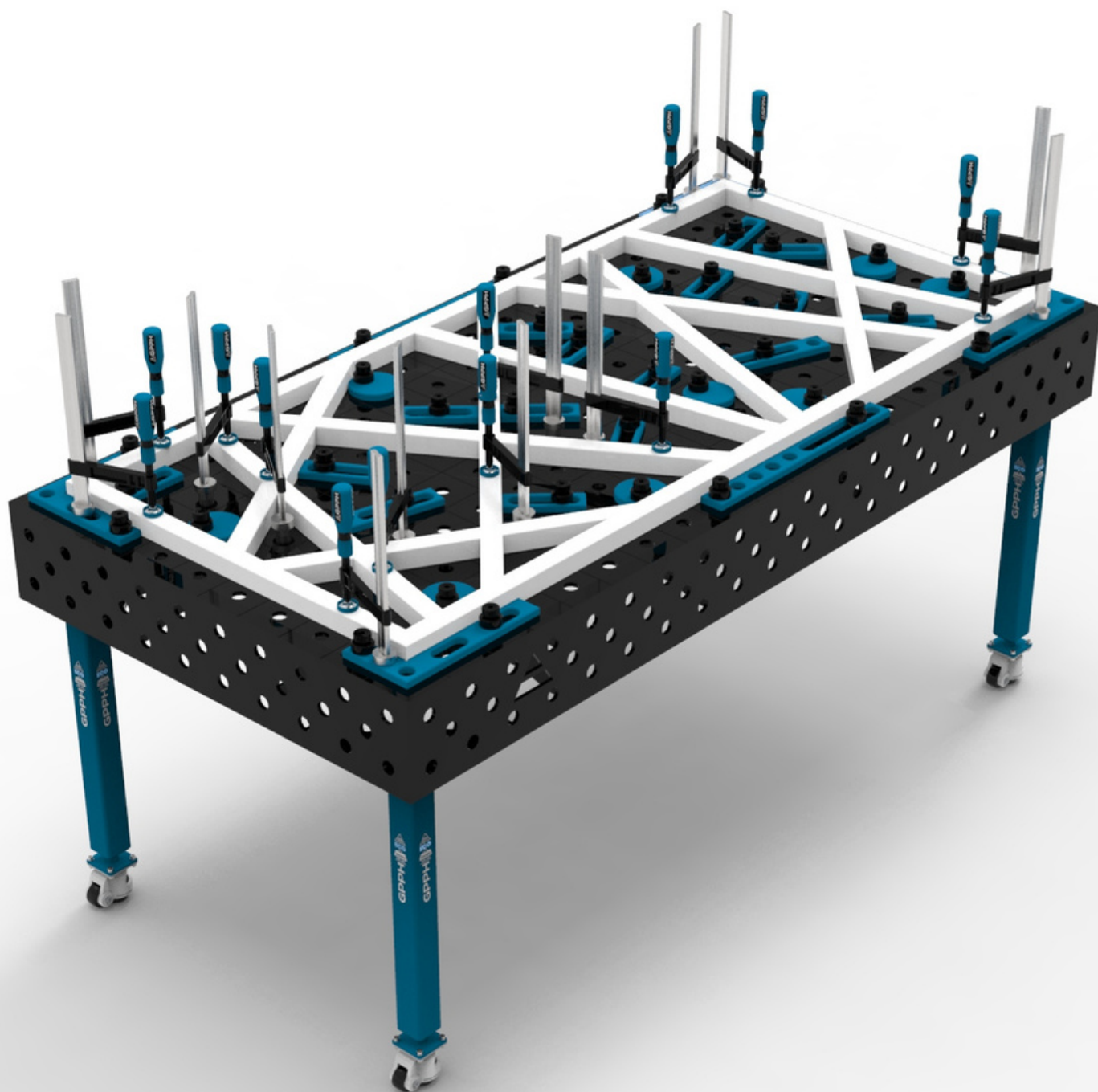

## TECHNICAL PARAMETERS

- ✓ Stable and massive construction
- ✓ The highest quality of workmanship
- ✓ Perfect flatness of the table [ +/ - 0,5mm ]
- ✓ Made of S355J2+N
- ✓ Holes of system  $\varnothing 16$  in the grid 50x50mm or 100x100mm or holes of system  $\varnothing 28$  in the grid 100x100mm
- ✓ Three grids of holes on the 4 sides
- ✗ Chamfered and milled holes to facilitate the assembly of tools (holes in the basic ECO version are laser cut)
- ✓ Engraved scale in the grid 100x100mm
- ✓ Height adjustment of the table with standard legs approx. 880-930mm
- ✓ Possibility of using stainless steel covers
- ✓ Tables can be combined freely to extend a working surface
- ✓ All tables are reinforced with ribs
- ✓ Produced with standard ISO 2768-1
- ✗ Milled worktop edges
- Thickness **8mm**
- Table legs made of profile **60x60mm**
- Capacity: **250kg/leg\***
- Tools from the PLUS series, fixed with the PLUS/ECO bolt, are compatible with the ECO series welding tables
- Table extensions and connectors from the ECO series are intended to increase the working surface of the ECO tables

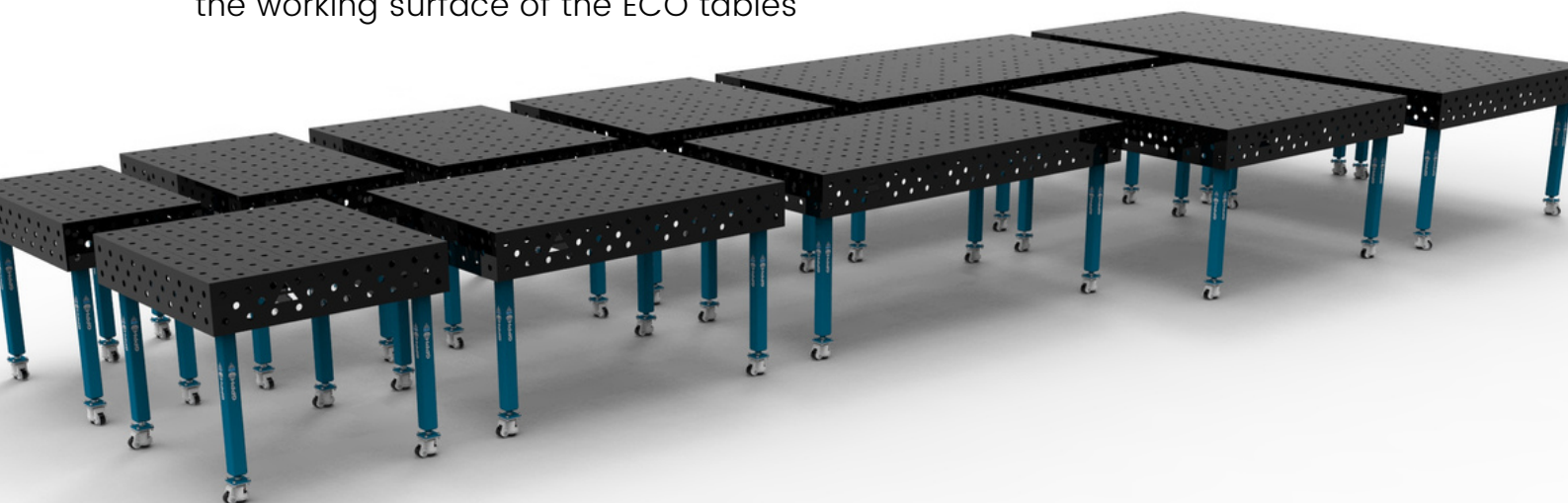

\*Applies to standard legs on the foot. When it comes to legs on wheels, it is the static load capacity - it refers to the situation where the table is supported on the feet protruding from the wheels.

# DIMENSIONS OF TRADITIONAL WELDING TABLES<sup>ECO</sup>

## GPPH TRDITIONAL WELDING TABLE<sup>ECO</sup> TWT.ECO.300148



- length x width: 3000x1480mm
- side plate: 200 mm
- table weight: approx. 530 kg
- capacity: 2 000 kg
- number of legs: 8

\* The 3000x1480 GPPH welding table consists of two 1500x1480 GPPH welding tables connected to each other.

## GPPH TRDITIONAL WELDING TABLE<sup>ECO</sup> TWT.ECO.240120



- length x width: 2400x1200mm
- side plate: 200 mm
- table weight: approx. 340 kg
- capacity: 1 500 kg
- number of legs: 6

# DIMENSIONS OF TRADITIONAL WELDING TABLES<sup>ECO</sup>

---

## GPPH TRDITIONAL WELDING TABLE<sup>ECO</sup> TWT.ECO.200100

---



- length x width: 2000x1000mm
- side plate: 200 mm
- table weight: approx. 250 kg
- capacity: 1 000 kg
- number of legs: 4

## GPPH TRDITIONAL WELDING TABLE<sup>ECO</sup> TWT.ECO.150148

---



- length x width: 1500x1480mm
- side plate: 200 mm
- table weight: approx. 270 kg
- capacity: 1 000 kg
- number of legs: 4

# DIMENSIONS OF TRADITIONAL WELDING TABLES<sup>ECO</sup>

---

## GPPH TRDITIONAL WELDING TABLE<sup>ECO</sup> TWT.ECO.150100

---



- length x width: 1500x1000mm
- side plate: 200 mm
- table weight: approx. 200 kg
- capacity: 1 000 kg
- number of legs: 4

## GPPH TRDITIONAL WELDING TABLE<sup>ECO</sup> TWT.ECO.120120

---



- length x width: 1200x1200mm
- side plate: 200 mm
- table weight: approx. 190 kg
- capacity: 1 000 kg
- number of legs: 4

# DIMENSIONS OF TRADITIONAL WELDING TABLES<sup>ECO</sup>

---

## GPPH TRDITIONAL WELDING TABLE<sup>ECO</sup> TWT.ECO.120100

---



- length x width: 1200x1000mm
- side plate: 200 mm
- table weight: approx. 170 kg
- capacity: 1 000 kg
- number of legs: 4

## GPPH TRDITIONAL WELDING TABLE<sup>ECO</sup> TWT.ECO.12080

---



- length x width: 1200x800mm
- side plate: 200 mm
- table weight: approx. 140 kg
- capacity: 1 000 kg
- number of legs: 4



# DIMENSIONS OF TRADITIONAL WELDING TABLES<sup>ECO</sup>

---

## GPPH TRDITIONAL WELDING TABLE<sup>ECO</sup> TWT.ECO.100100

---



- length x width: 1000x1000mm
- side plate: 200 mm
- table weight: approx. 150 kg
- capacity: 1 000 kg
- number of legs: 4

## GPPH TRDITIONAL WELDING TABLE<sup>ECO</sup> TWT.ECO.10060

---



- length x width: 1000x600mm
- side plate: 200 mm
- table weight: approx. 110 kg
- capacity: 1 000 kg
- number of legs: 4

## NEED MORE MOBILITY OF YOUR WELDING TABLE?

CHECK OUT OUR OFFER OF WELDING TABLES  
ON LEGS WITH WHEELS!

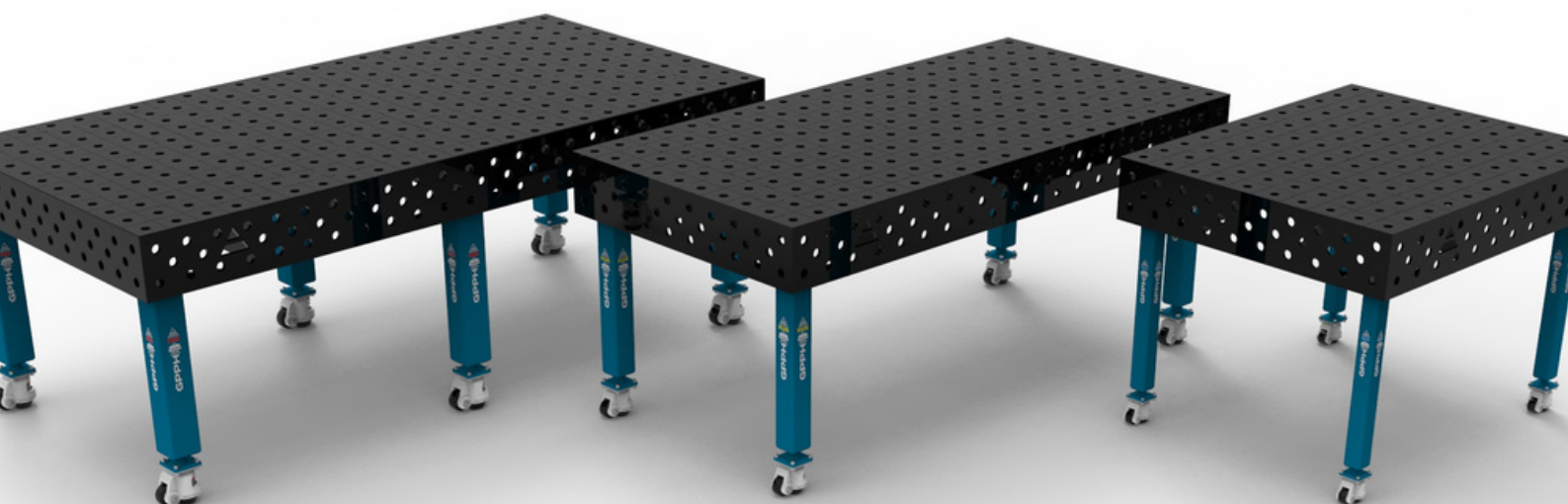

---

\*The price of a leg on a wheel should be multiplied by the number of legs in the selected dimensional version, and then the total should be added to the net price of the chosen Welding Table.  
When ordering legs with wheels, the customer receives only this version of the legs (no legs with feet).

## DO YOU WELD STAINLESS STEEL ELEMENTS AND STRUCTURES?

CHECK OUR OFFER OF STAINLESS STEEL COVERS FOR GPPH TRADITIONAL WELDING TABLES!

The covers are made of 1mm thick stainless steel.

Put a cover on the Traditional GPPH Welding Table to transform it into an ideal table for welding stainless steel.

The hole pattern of the stainless steel cover is the same as the hole pattern of a Traditional Welding Table.

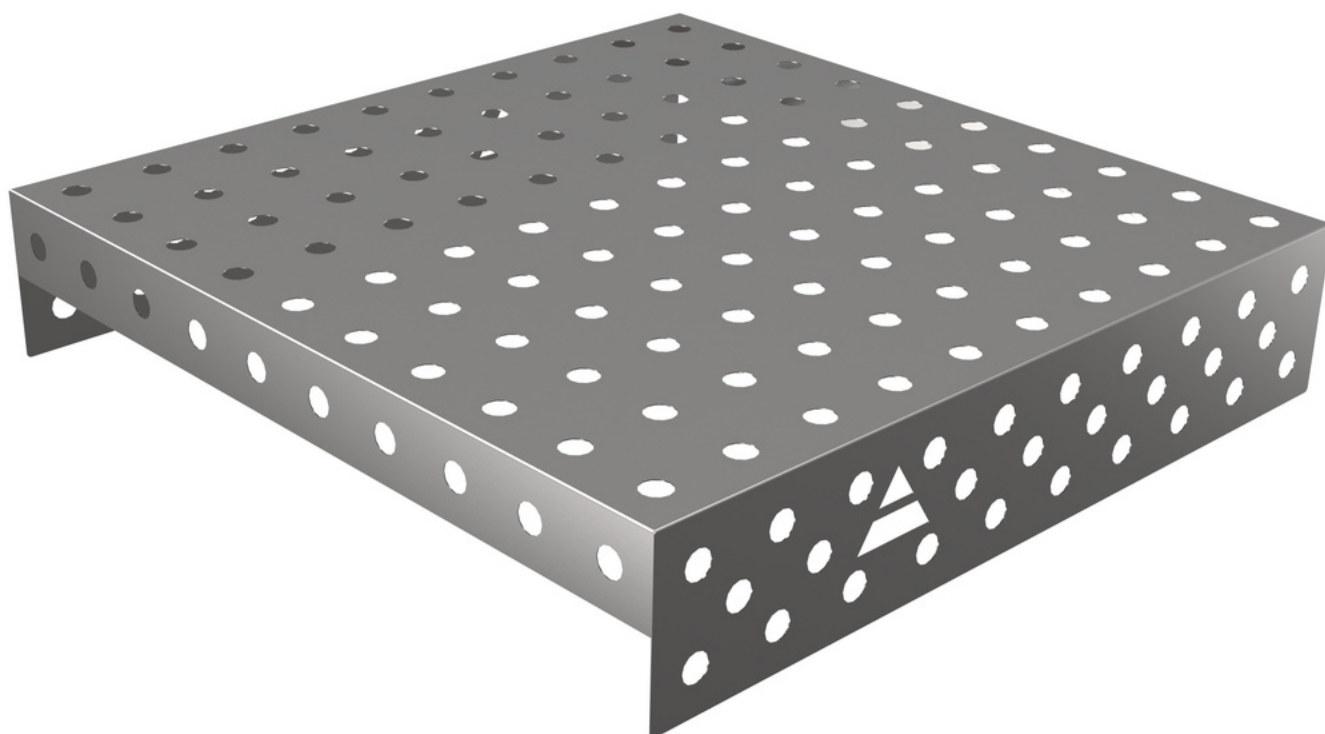

\*Valuation of the stainless steel cover only on request.

# ASSEMBLY-WELDING TABLE **DIY**



## TECHNICAL PARAMETERS

---

- Length x width: 1200x800mm
- Stable screwed frame construction
- Tables can be combined freely to extend a working surface
- The highest quality of workmanship
- Produced with standard ISO 2768-1
- Perfect flatness of the table [ +/ - 0,5mm ]
- Made of S355J2+N
- Holes of system  $\varnothing 16$  in the grid 50x50mm
- Engraved scale in the grid 100x100mm
- Leveling feet to compensate for unevenness of the flooring
- Height adjustment at the leveling feet
- Welded reinforcement ribs
- Thickness: 8 mm
- Capacity: 500 kg
- Table weight: approx. 90 kg
- Tools from the PLUS series, fixed with the bolt PLUS/ECO of the 16 system, are compatible with the DIY welding tables



## TECHNICAL PARAMETERS

ASSEMBLY-WELDING TABLE **DIY** CONSISTS OF:

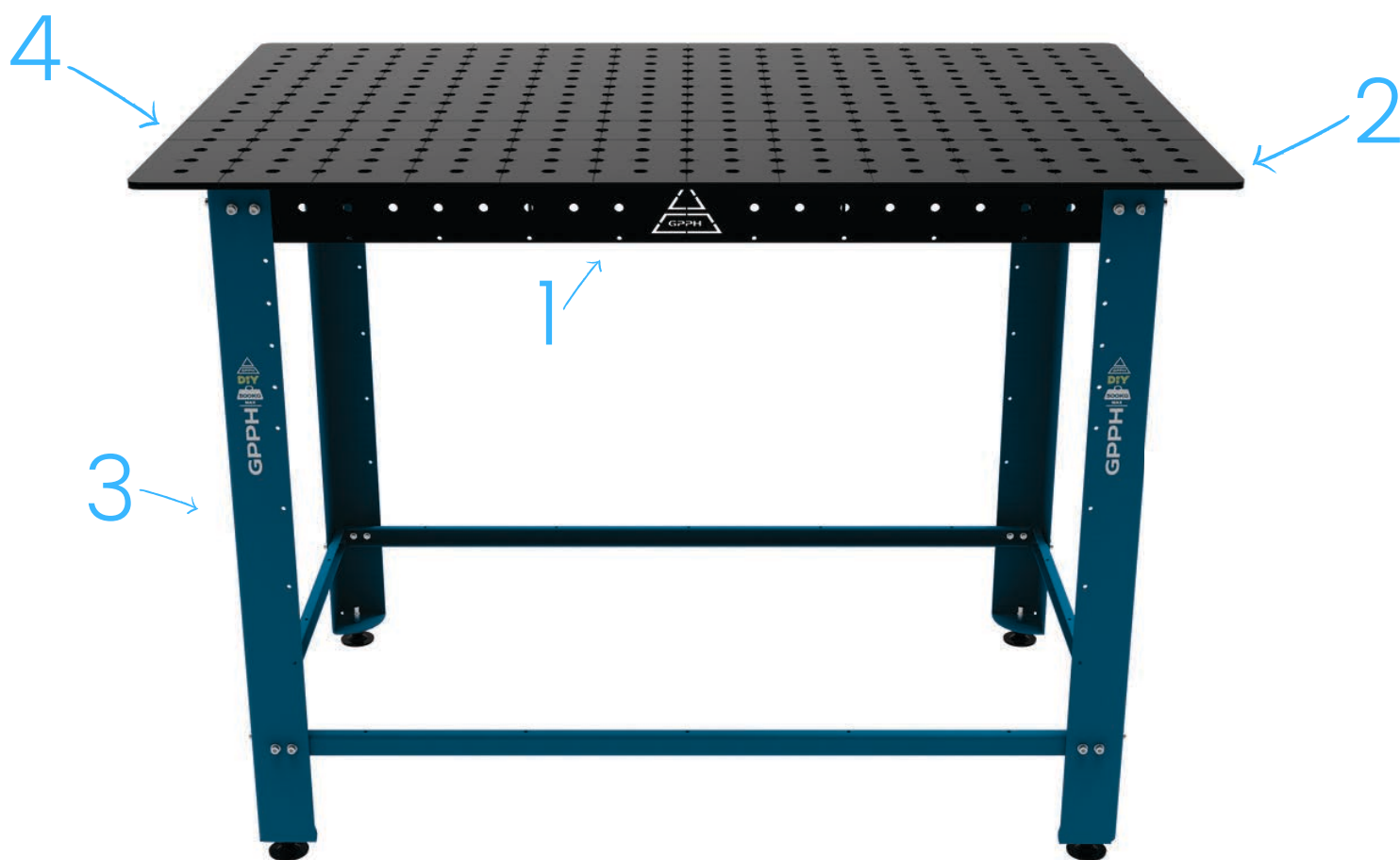

1. Metal rigid frame reinforced with ribs
2. Working table 8 [mm] thick made of S355J2+N steel
3. Legs equipped with leveling feet to compensate for unevenness of the flooring
4. Engraved scale in the grid 100x100 [mm] and assembly holes of system 16, in the grid 50x50

# APPLICATIONS OF THE ASSEMBLY-WELDING TABLE DIY

---



## AS A TABLE FOR CNC MACHINERY

---

The DIY assembly-welding table is ideal for use in the production plants as an auxiliary table for the replacement of jigs in the tool holders and measurements of the produced components.



## FOR DIY-MEN

---

The DIY assembly-welding table is perfect to pursue your passions e.g. welding or do-it-yourself. It facilitates operations with the tools of any DIY-man.



## FOR JOINERS

---

It facilitates the cutting and assembly of furniture components. Additional equipment assists in the fitting of the components, used during the works, with greater accuracy and facilitates working alone.



## FOR MECHANICS

---

It is particularly suitable for repairs of vehicle components and during welding, grinding works, and other works related to mechanics.

# APPLICATIONS OF THE ASSEMBLY-WELDING TABLE DIY

---



## FOR WORKSHOPS

---

The DIY assembly-welding table is ideal for fixing the drill, vice, and other workshop tools. It ensures that ground components are firmly attached to the worktop.



## FOR WELDERS

---

The additional equipment of the DIY assembly-welding table makes that welding works are accurate, comfortable, and quick. Execution of small and large welding batches has never been this easy!



## FOR CONSTRUCTION WORKERS

---

It is light and mobile and therefore it can be taken to any construction site. It can be used to cut the materials and weld the components directly on the construction site.



## FOR FARMERS

---

Ideal as an assembly-welding table for production and repair of the components of the agricultural machinery. It is perfect also during service and maintenance operations of wear and tear parts.



# ADDITIONAL EQUIPMENT FOR **DIY** WELDING TABLES

## TOOLKITS **DIY**

Number of jigs & fixtures included in the kit: 35

TOOLS **PLUS**, Ø 16



## **DIY** ADAPTER FOR MOBILE SHELVES

ADAPTER FOR  
MOBILE SHELVES  
D.001 | Cat. No.

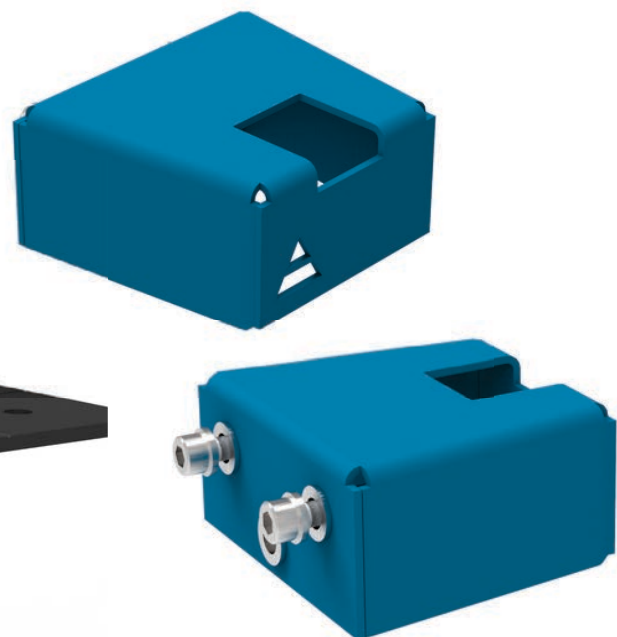

# MODULAR WELDING TABLES

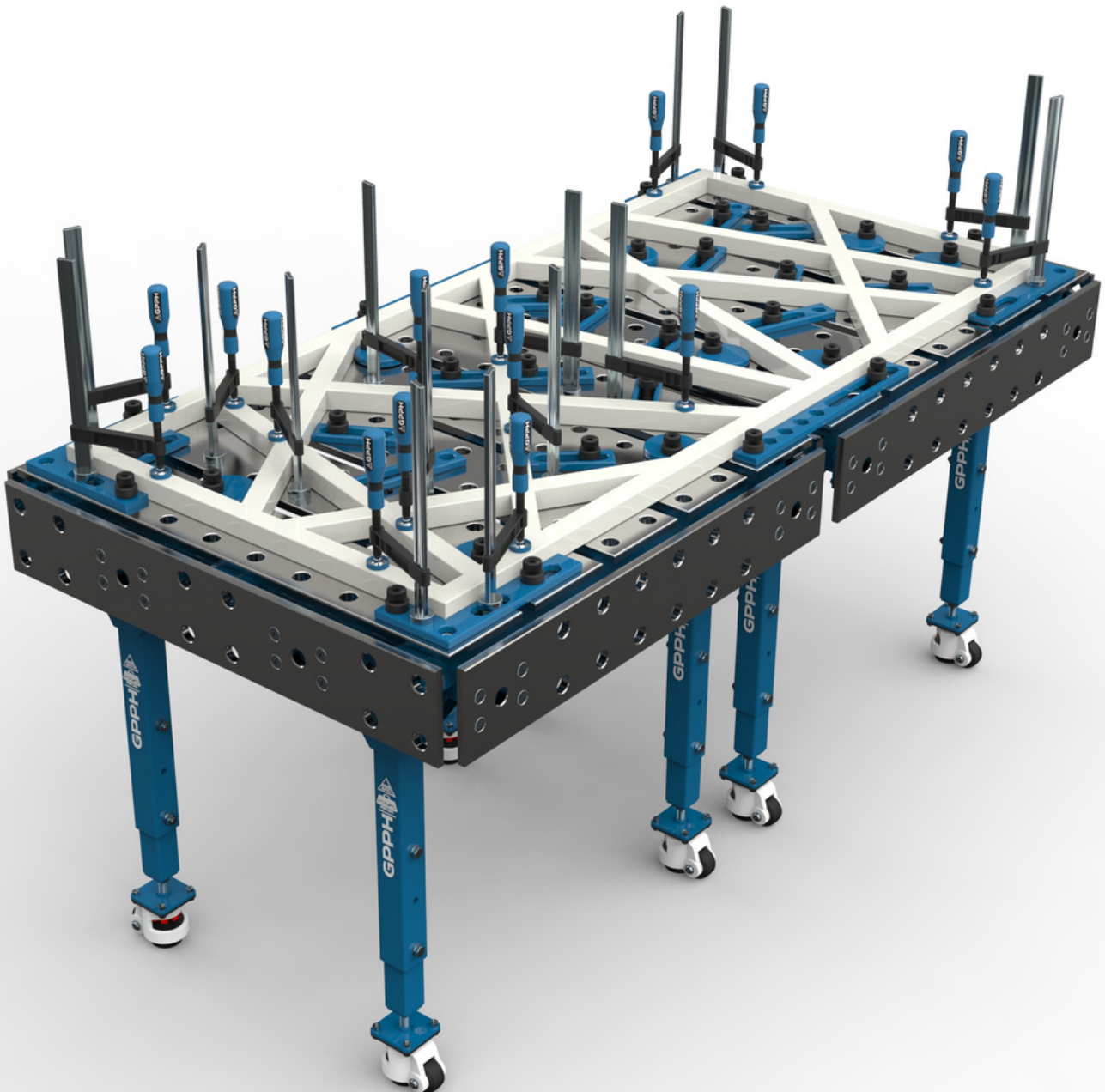

## TECHNICAL PARAMETERS

- Stable construction
- The highest quality of workmanship
- Perfect flatness of the table due to the ability to adjust the surface in three places
- Hole and slot possibility of tools installation
- Two versions of worktop plates:
  - material: S355J2+N
  - material: tool steel subjected to the following machining processes: nitriding + oxidation
- Thickness 15mm
- Holes of system  $\varnothing 28$  in the grid 100x100
- Chamfered and milled holes for easy tool assembly
- Wheels with supports in the standard leg
- Adjustable supports in additional legs - in staggered versions
- Adjustable table height in the range of 850mm – 1150mm, P=50mm
- Tables can be combined freely to extend a working surface
- Milled plate surface
- Set of side plates purchase option
- Produced following standard ISO 2768-1
- Capacity: 250kg/leg
- Tools from the PRO, PLUS, and ECO lines are also compatible with GPPH Modular Tables

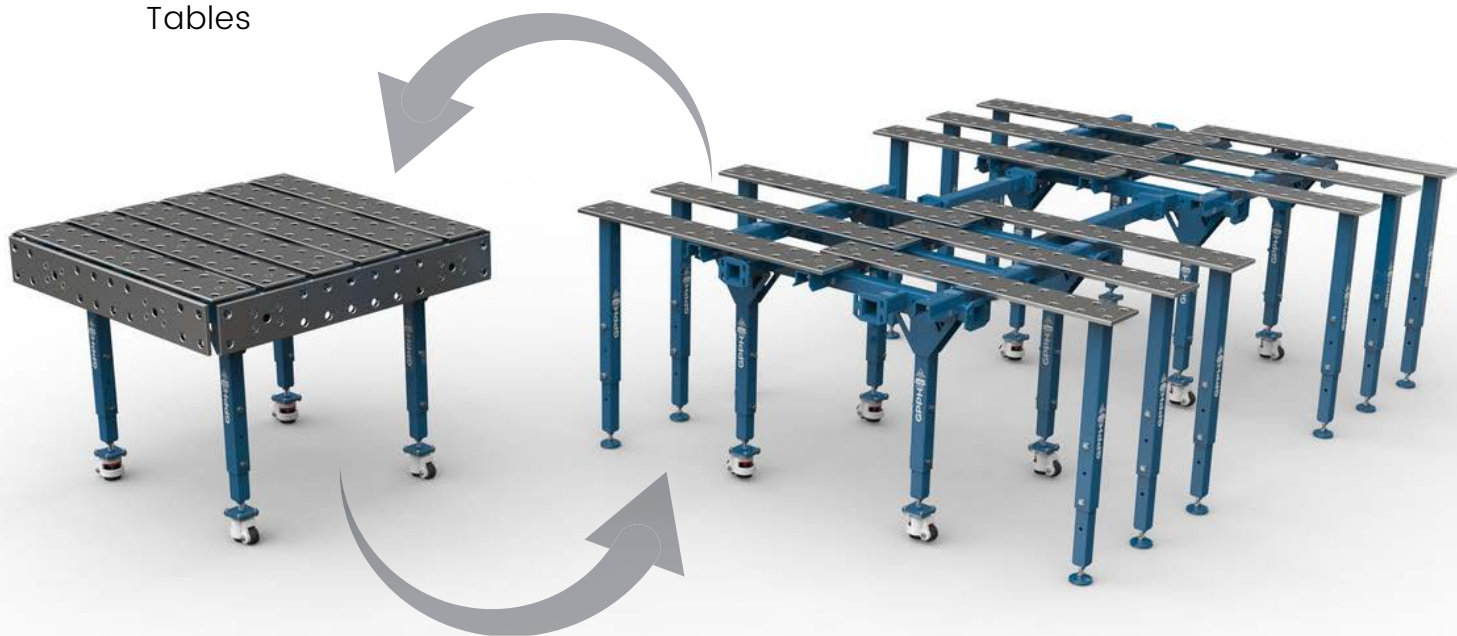

# TECHNICAL PARAMETERS

---



## SINGLE TABLE

---

We offer three standard versions. They are ideal for smallscale production or serve as the basis for unlimited expansion of the surface of the welding station.



## EXTENDABLE SINGLE TABLE

---

Each table from our offer can be unfolded thanks to sliding plates and the use of additional legs.



## DOUBLE TABLE

---

The most popular sets are sets composed of two single tables. The design of the tables allows expansion in every direction.



## SET WITH A LARGE WORK SURFACE

---

Connection of two unfolded tables by means of connectors are the perfect solution for the spatial construction.

# ADVANTAGES AND BENEFITS OF MODULAR TABLES

---

## PERFECT FLATNESS

Due to the possibility of adjusting the height of the countertops through spacers, the operator can set a perfect working surface of the table. This solution allows the user to use the table for many years while maintaining a perfect surface of the countertop.



## HOLE AND SLOT MOUNTING TOOLS

Ø28 holes are standard in the table in a 100x100mm grid. Besides, the design of our modular tables allows you to increase the number of places for mounting tools in the gaps between the top plates - increased ergonomics.

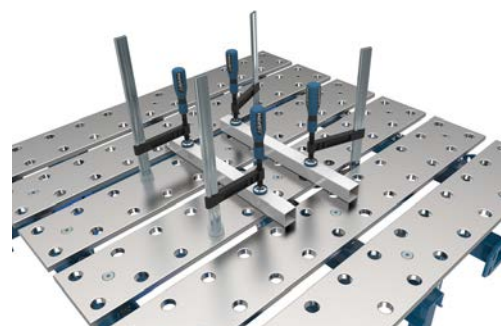

## ADJUSTABLE PLATES

We can move them by increasing the working surface, as well as exchanging them for new ones, which affects the various adaptation of the table to the currently performed works and longevity of use.



# ADVANTAGES AND BENEFITS OF MODULAR TABLES

---

## INCREASING WORKING AREA

Done by sliding plates (as above), but above all, we obtain it by quickly joining together many tables in table set. The working area can be expanded in different directions. The operator can adjust the arrangement of tables depending on the current location in the production hall.



## ADJUSTABLE TABLE HEIGHT

Range from 850mm to 1150mm, every 50mm. The possibility of adapting the station making an impact on the ergonomics of work for many operators.



## FLEXIBILITY OF THE NUMBER OF WELDING STATIONS

A variety of configurations, increasing the space by joining them, as well as increasing the number of positions by diving them.



# NON-NITRIDED MODULAR WELDING TABLES

Material of worktop plates: S355J2+N

## SINGLE TABLE



### DIMENSIONS | NET PRICE

- Table 1000x1000 [mm]
- Table 1200x1200 [mm]
- Table 1600x1500 [mm]

## EXTENDABLE SINGLE TABLE



### DIMENSIONS | NET PRICE

- Table 1770x1000 [mm] (Table 1000x1000mm + 5x legs)
- Table 2170x1200 [mm] (Table 1200x1200mm + 6x legs)
- Table 2670x1600 [mm] (Table 1500x1600mm + 8x legs)

# NON-NITRIDED MODULAR WELDING TABLES

Material of worktop plates: S355J2+N

## DOUBLE TABLE



### DIMENSIONS | NET PRICE

- Table 2000x1000 [mm] (2x Tables 1000x1000)
- Table 2400x1200 [mm] (2x Tables 1200x1200)
- Table 3200x1500 [mm] (2x Tables 1600x1500)

## SET WITH A LARGE WORK SURFACE



### DIMENSIONS | NET PRICE

- Table 1770x2630 [mm]  
(2x Tables 1000x1000 + 2x connector L=630 mm + 10x legs)
- Table 2170x3030 [mm]  
(2x Tables 1200x1200 + 2x connector L=630 mm + 12x legs)
- Table 2670x4000 [mm]  
(2x Tables 1500x1600 + 2x connector L=800 mm + 16x legs)



# NITRIDED MODULAR WELDING TABLES

Material of worktop plates: tool steel subjected to the following machining processes: nitriding + oxidation

## SINGLE TABLE



### DIMENSIONS | NET PRICE

- Table 1000x1000 [mm]
- Table 1200x1200 [mm]
- Table 1600x1500 [mm]

## EXTENDABLE SINGLE TABLE



### DIMENSIONS | NET PRICE

- Table 1770x1000 [mm] (Table 1000x1000mm + 5x legs)
- Table 2170x1200 [mm] (Table 1200x1200mm + 6x legs)
- Table 2670x1600 [mm] (Table 1500x1600mm + 8x legs)

# NITRIDED MODULAR WELDING TABLES

Material of worktop plates: tool steel subjected to the following machining processes: nitriding + oxidation

## DOUBLE TABLE



### DIMENSIONS | NET PRICE

- Table 2000x1000 [mm] (2x Tables 1000x1000)
- Table 2400x1200 [mm] (2x Tables 1200x1200)
- Table 3200x1500 [mm] (2x Tables 1600x1500)

## SET WITH A LARGE WORK SURFACE



### DIMENSIONS | NET PRICE

- Table 1770x2630 [mm]  
(2x Tables 1000x1000 + 2x connector L=630 mm + 10x legs)
- Table 2170x3030 [mm]  
(2x Tables 1200x1200 + 2x connector L=630 mm + 12x legs)
- Table 2670x4000 [mm]  
(2x Tables 1500x1600 + 2x connector L=800 mm + 16x legs)

## ADDITIONAL EQUIPMENT FOR MODULAR WELDING TABLE

---



---

### SET OF NON-NITRIDED SIDE PLATES

For a table with  
dimensions:  
1000x1000 [mm]  
1200x1200 [mm]  
1500x1600 [mm]



---

### SET OF NITRIDED SIDE PLATES

For a table with  
dimensions:  
1000x1000 [mm]  
1200x1200 [mm]  
1500x1600 [mm]

# GRINDING-WELDING STATION

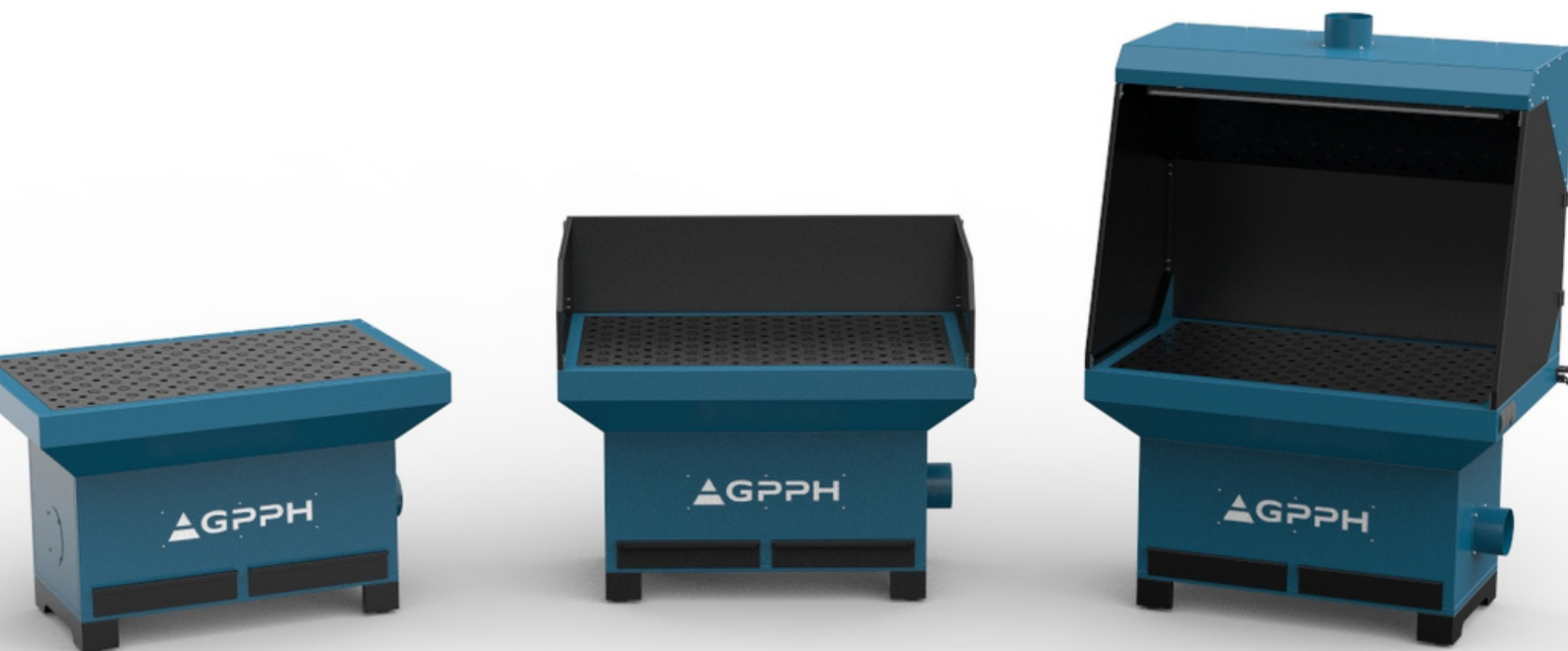

## TECHNICAL PARAMETERS

---

The grinding-welding station is intended for capturing and removing the dust and gases formed during grinding with a hand grinder or welding and metalworking operations. The station may be used with an exhaust fan or fan-powered filter equipment.

The GPPH grinding-welding station is available in three versions:

- Grinding-welding station - base
- Grinding-welding station - base with guards
- Grinding-welding station - base with top exhaust

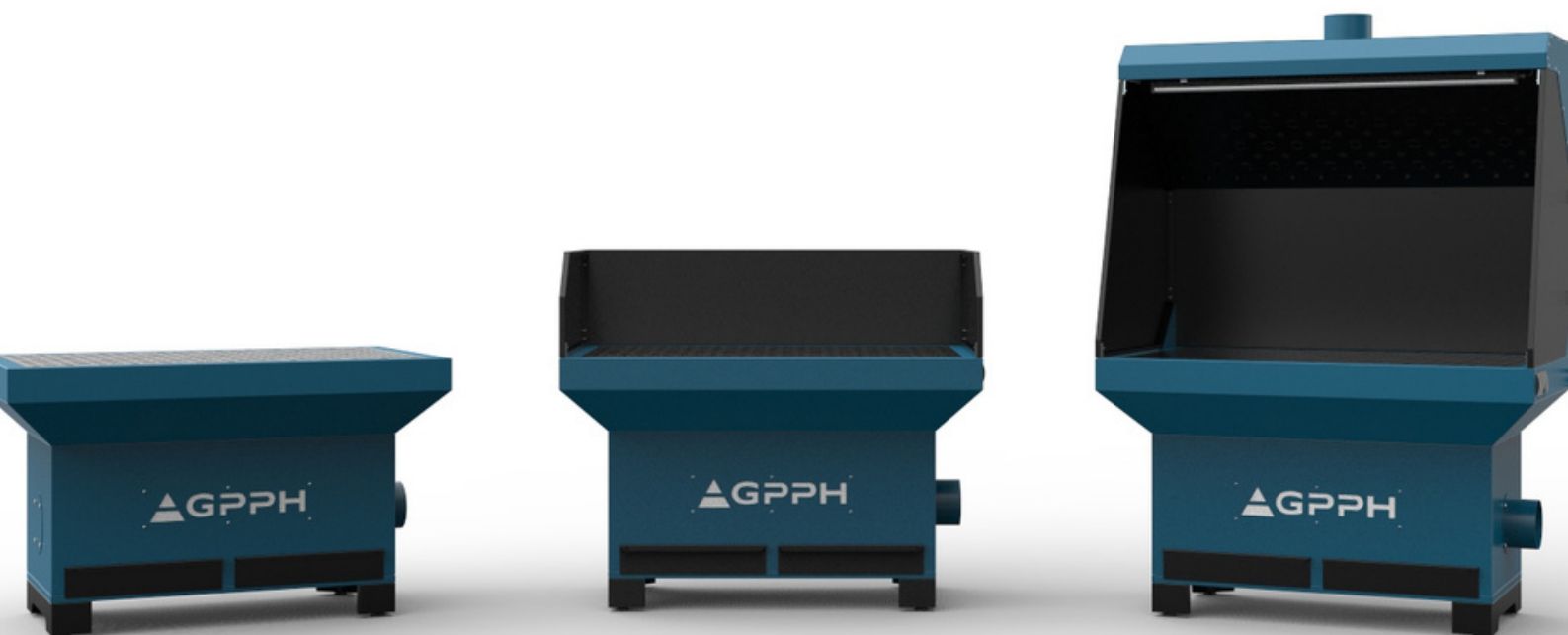

## TECHNICAL PARAMETERS – BASE

---

### FEATURES – BASE:

S.P.001 | Cat. No.

- The base is adapted for the installation of guards and a top exhaust system
- Connector Ø160mm installed in the side surface of the exhaust trough
- The air may be exhausted from the bottom through the table of exhaust trough
- Worktop made of 8mm sheet of the dimensions 1270x770 – assembly holes in the grid 100x100 of system 28 and additional holes for the exhaust for dust and gases
- Weight: 167 kg
- Recommended air flow: 3200 m<sup>3</sup>/h
- Resistance of flow: 250 Pa



### THE S.P.001 STATION CONTAINS THE FOLLOWING COMPONENTS:

---

- Working table with a worktop made of 8 mm sheet
- Exhaust trough with drawers
- Two 230V plug sockets for connection of electrical power hand tools
- System for connection of workspace lighting
- Connector for exhaust hose

# TECHNICAL PARAMETERS – BASE WITH GUARDS

## FEATURES – BASE WITH GUARDS:

S.O.001 | Cat. No.

- Working surface guard
- Tilting doors - components of length exceeding the width of the table (1400 mm) can be placed on the working table
- Connector Ø160mm installed in the side surface of the exhaust trough
- The air may be exhausted from the bottom through the table of exhaust trough
- Worktop made of 8mm sheet of the dimensions 1270x770- assembly holes in the grid 100x100 of system 28 and additional holes for the exhaust for dust and gases
- Weight: 190 kg
- Recommended air flow: 3200 m<sup>3</sup>/h
- Resistance of flow: 250 Pa

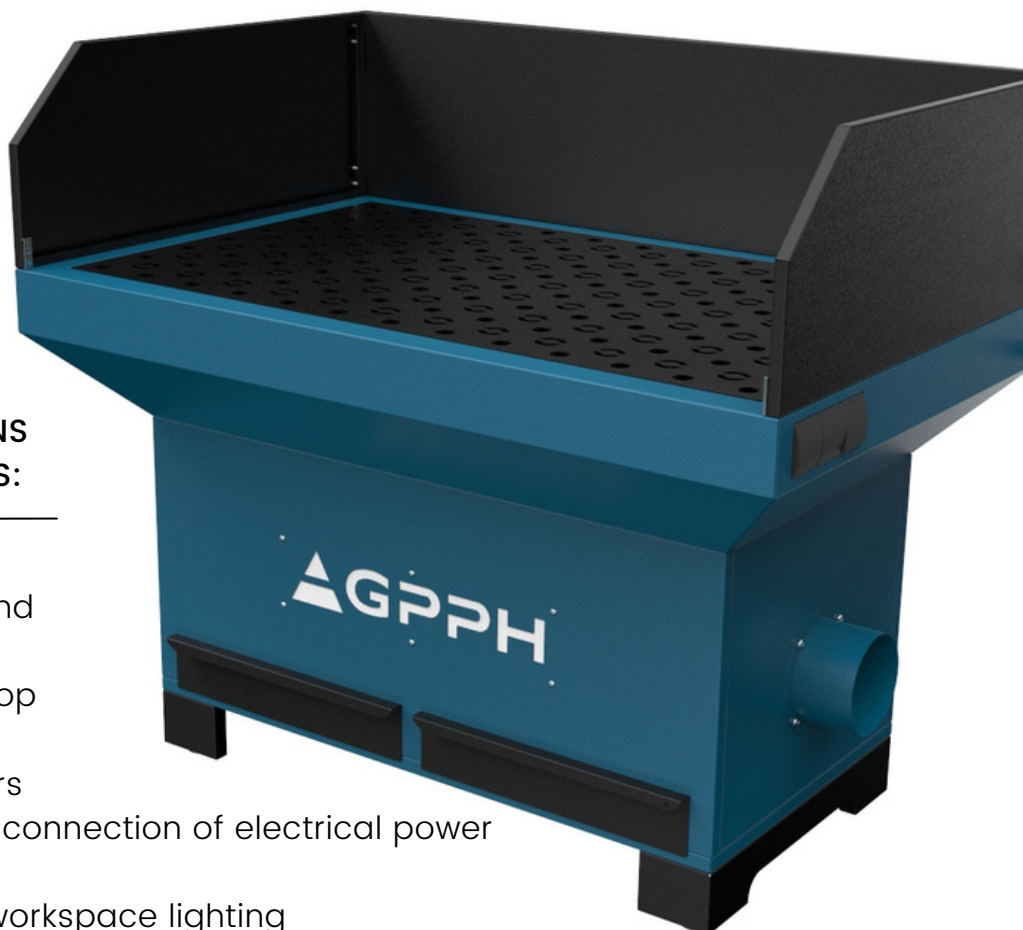

### THE S.O.001 STATION CONTAINS THE FOLLOWING COMPONENTS:

- Rear guard
- Tilting doors on the right and left side
- Working table with a worktop made of 8 mm sheet
- Exhaust trough with drawers
- Two 230V plug sockets for connection of electrical power hand tools
- System for connection of workspace lighting
- Connector for exhaust hose

# TECHNICAL PARAMETERS – BASE WITH TOP EXHAUST

## FEATURES – BASE WITH TOP EXHAUST:

S.OG.001 | Cat. No.

- Working surface guards
- Top exhaust system
- Tilting doors - components of length exceeding the width of the table (1400 mm) can be placed on the working table
- Connector Ø160mm installed in the side surface of the exhaust trough and top surface of the housing
- The air may be exhausted from the bottom through the table of exhaust trough and from the top through the holes in the housing.
- Worktop made of 8mm sheet of the dimensions 1270x770 - assembly holes in the grid 100x100 of system 28 and additional holes for the exhaust for dust and gases
- LED lighting
- Weight: 264 kg
- Recommended air flow: 3200 m<sup>3</sup>/h
- Resistance of flow: 250 Pa



## THE S.OG.001 STATION CONTAINS THE FOLLOWING COMPONENTS:

- Working table with a worktop made of 8 mm sheet
- Exhaust trough with drawers
- Top exhaust system
- Tilting doors on the right and left side
- Two 230V plug sockets for connection of electrical power hand tools
- Work area lighting system



# ADDITIONAL EQUIPMENT FOR GPPH WELDING TABLES

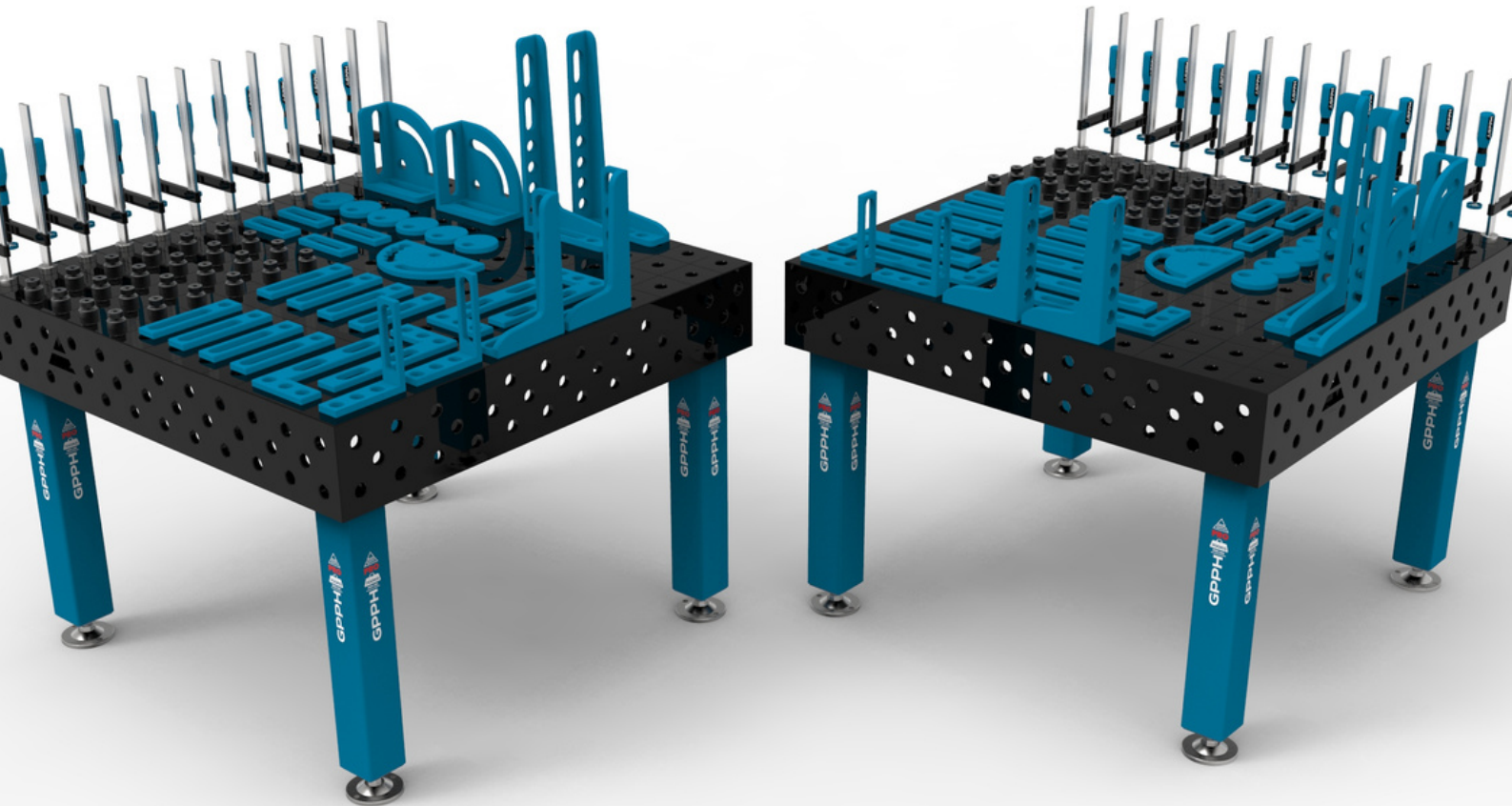

# FLAT TOOLS<sup>PRO</sup>

Tools 15mm thick. Milled worktop edges, milled and chamfered edges, and two-sided milled and chamfered holes.



**STOP PRO 150**  
N.004PRO | Cat. No.



**STOP PRO 225**  
N.005PRO | Cat. No.



**STOP PRO 260**  
N.006PRO | Cat. No.



**STOP PRO 500**  
N.007PRO | Cat. No.



**PROTRACTOR PRO**  
N.008PRO | Cat. No.



**ANGLE PRECISION  
SQUARE (FLAT)  
PRO 275X150**  
N.009PRO | Cat. No.



**ANGLE PRECISION  
SQUARE (FLAT)  
PRO 320X150**  
N.010PRO | Cat. No.



**ANGLE PRECISION  
SQUARE (FLAT)  
PRO 350X250**  
N.011PRO | Cat. No.



**ECCENTRIC STOP  
PRO Ø100**  
N.003PRO | Cat. No.

## SPATIAL TOOLS **PRO**

Tools 15mm thick. Milled worktop edges, milled and chamfered edges, and two-sided milled and chamfered holes.



**ANGLE BRACKET  
PRO 185X175**  
N.012PRO | Cat. No.



**ANGLE BRACKET  
PRO 200X200**  
N.0013PRO | Cat. No.



**ANGLE BRACKET  
PRO 300X190**  
N.014PRO | Cat. No.



**ANGLE BRACKET  
PRO 450X250**  
N.015PRO | Cat. No.

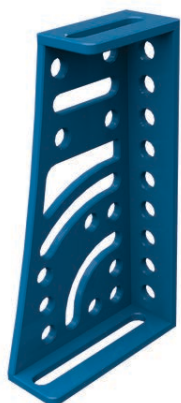

**ANGLE BRACKET PRO  
275X500X175X100**  
N.016PRO | Cat. No.

## INCREASING THE WORK SURFACE<sup>PRO</sup>

---



TABLE EXTENSION PRO  
1000X100  
N.017PRO | Cat. No.



TABLE EXTENSION PRO  
1000X200  
N.018PRO | Cat. No.



WELDING CONNECTION  
BLOCK PRO 1000X200X200  
N.019PRO | Cat. No.

# ASSEMBLY TOOLS <sup>PRO</sup>



## MOUNTING PIN PRO

T.015PRO | Cat. No.

The PRO mounting pin allows seamless connection of the PRO Welding Tables and therefore increasing their working surface.



## FAST ASSEMBLY BOLT 30 PRO

N.002PRO | Cat. No.

The 30 PRO fast assembly bolt is suited for mounting PRO tools on a PRO Welding Table.



## FAST ASSEMBLY BOLT UNI

N.002UNI | Cat. No.

The UNI fast assembly bolt is the most universal. Thanks to it, you can, for example, mount tools from the PLUS series on the Welding Table from the PRO series.



## MAGNETIC FAST ASSEMBLY BOLT PRO

N.002MG.PRO | Cat. No.

The magnetic clamping pin allows quick attachment of tools or construction elements anywhere on the welding table. Due to magnetic properties it is possible to fasten construction elements and tools in a way that is impossible with traditional pins, there is no need for mounting holes.

# FLAT TOOLS<sup>PLUS</sup>

Tools 11mm thick. Milled worktop edges, milled edges, and two-sided milled and chamfered holes.



**STOP PLUS 150**  
N.004PLUS | Cat. No.



**STOP PLUS 225**  
N.005PLUS | Cat. No.

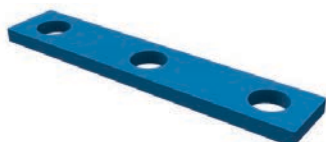

**STOP PLUS 260**  
N.006PLUS | Cat. No.



**STOP PLUS 500**  
N.007PLUS | Cat. No.



**PROTRACTOR PLUS**  
N.008PLUS | Cat. No.



**ANGLE PRECISION  
SQUARE (FLAT)  
PLUS 275X150**  
N.009PLUS | Cat. No.



**ANGLE PRECISION  
SQUARE (FLAT)  
PLUS 320X150**  
N.010PLUS | Cat. No.



**ANGLE PRECISION  
SQUARE (FLAT)  
PLUS 350X250**  
N.011PLUS | Cat. No.



**ECCENTRIC STOP  
PLUS Ø100**  
N.003PLUS | Cat. No.

## SPATIAL TOOLS **PLUS**

Tools 11mm thick. Milled worktop edges, milled edges, and two-sided milled and chamfered holes.



**ANGLE BRACKET  
PLUS 185X175**  
N.012PLUS | Cat. No.



**ANGLE BRACKET  
PLUS 200X200**  
N.013PLUS | Cat. No.



**ANGLE BRACKET  
PLUS 300X190**  
N.014PLUS | Cat. No.



**ANGLE BRACKET  
PLUS 450X250**  
N.015PLUS | Cat. No.

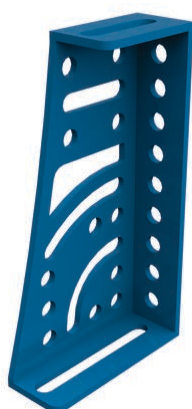

**ANGLE BRACKET PLUS**  
**275X500X175X100**  
N.016PLUS | Cat. No.

## INCREASING THE WORK SURFACE<sup>PLUS</sup>

---



TABLE EXTENSION PLUS  
1000X100  
N.017PLUS | Cat. No.



TABLE EXTENSION PLUS  
1000X200  
N.018PLUS | Cat. No.



WELDING CONNECTION  
BLOCK PLUS 1000X200X200  
N.019PLUS | Cat. No.



## ASSEMBLY TOOLS <sup>PLUS</sup>



### MOUNTING PIN PLUS

T.015PLUS | Cat. No.

The PLUS mounting pin allows seamless connection of the PLUS Welding Tables and therefore increasing their working surface.



### FAST ASSEMBLY BOLT 23 PLUS

N.002PLUS | Cat. No.

The 23 PLUS fast assembly bolt is suited for mounting PLUS tools on a PLUS Welding Table.



### FAST ASSEMBLY BOLT UNI

N.002UNI | Cat. No.

The UNI fast assembly bolt is the most universal. Thanks to it, you can, for example, mount tools from the PLUS series on the Welding Table from the PRO series.



### MAGNETIC FAST ASSEMBLY BOLT PLUS

N.002MG.PLUS | Cat. No.

The magnetic clamping pin allows quick attachment of tools or construction elements anywhere on the welding table. Due to magnetic properties it is possible to fasten construction elements and tools in a way that is impossible with traditional pins, there is no need for mounting holes.

## INCREASING THE WORK SURFACE<sup>ECO</sup>

---

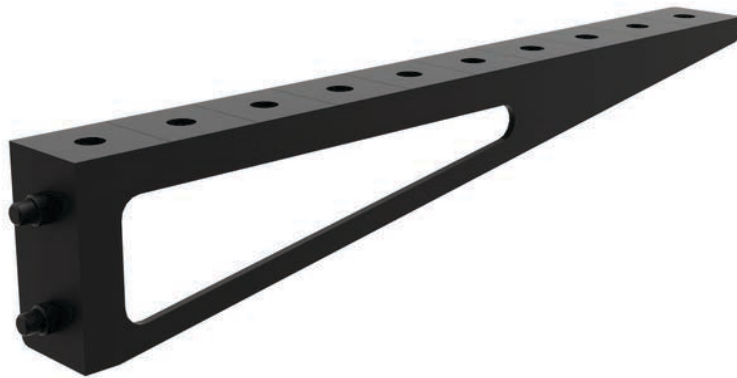

TABLE EXTENSION ECO

1000X100

N.017ECO | Cat. No.



TABLE EXTENSION ECO

1000X200

N.018ECO | Cat. No.

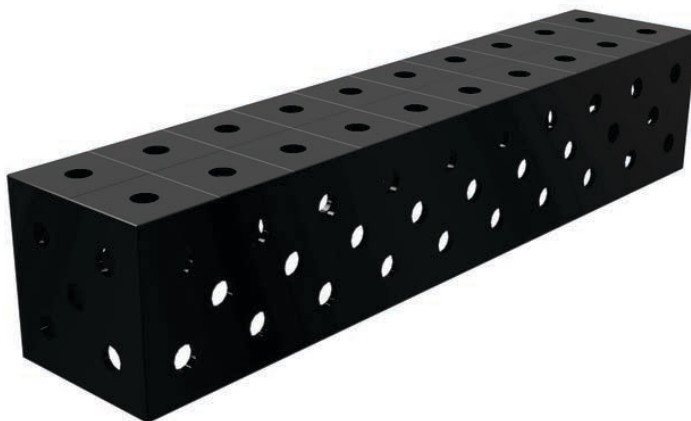

WELDING CONNECTION

BLOCK ECO 1000X200X200

N.019ECO | Cat. No.

## ASSEMBLY TOOLS <sup>ECO</sup>



### MOUNTING PIN ECO

T.015ECO | Cat. No.

The ECO mounting pin allows seamless connection of the ECO Welding Tables and therefore increasing their working surface.



### FAST ASSEMBLY BOLT PLUS/ECO

N.002PLUS/ECO | Cat. No.

The 23 PLUS fast assembly bolt is suited for mounting PLUS tools on a PLUS Welding Table.



### FAST ASSEMBLY BOLT UNI

N.002UNI | Cat. No.

The UNI fast assembly bolt is the most universal. Thanks to it, you can, for example, mount tools from the PLUS series on the Welding Table from the PRO series.



### MAGNETIC FAST ASSEMBLY BOLT PLUS

N.002MG.PLUS | Cat. No.

The magnetic clamping pin allows quick attachment of tools or construction elements anywhere on the welding table. Due to magnetic properties it is possible to fasten construction elements and tools in a way that is impossible with traditional pins, there is no need for mounting holes.

# FASTENING CLAMPS



**FASTENING CLAMP**  
N.001A | Cat. No.



**FASTENING CLAMP  
WITH LEVER**  
N.001B | Cat. No.



**VARIABLE THROAT  
DEPTH CLAMP**  
N.001C | Cat. No.

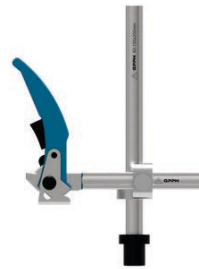

**VARIABLE THROAT  
DEPTH WITH  
LEVER CLAMP**  
N.001D | Cat. No.



**FASTENING CLAMP**  
N.001E | Cat. No.



**FASTENING CLAMP  
WITH LEVER**  
N.001F | Cat. No.

# PRISMS, WELDING TORCH HANDLE, TOOL SHELVES

---

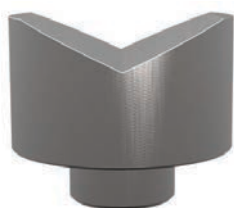

**PRISM**  
Ø58mm 130°  
N.021 | Cat. No.



**PRISM**  
Ø58mm 130°/90°  
N.023 | Cat. No.



**PRISM**  
Ø58mm 90°  
N.022 | Cat. No.



**WELDING TORCH  
HANDLE**  
N.020 | Cat. No.



**FAST ASSEMBLY  
BOLT SHELF S**  
T.011A | Cat. No.



**FAST ASSEMBLY  
BOLT SHELF M**  
T.011B | Cat. No.

# TOOL SHELVES



**CLAMP SHELF S**  
T.011C | Cat. No.



**CLAMP SHELF M**  
T.011D | Cat. No.



**FLAT SHELF S**  
T.011E | Cat. No.



**FLAT SHELF M**  
T.011F | Cat. No.



**FLAT SHELF L**  
T.011G | Cat. No.



**MOBILE SHELF  
FOR EXTENSIONS**  
T.011J | Cat. No.

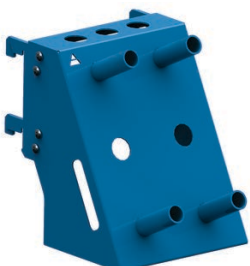

**MIX SHELF**  
T.011H | Cat. No.



**DOCUMENTATION  
SHELF**  
T.011I | Cat. No.

# TOOLKIT PROPOSAL FOR GPPH WELDING TABLES

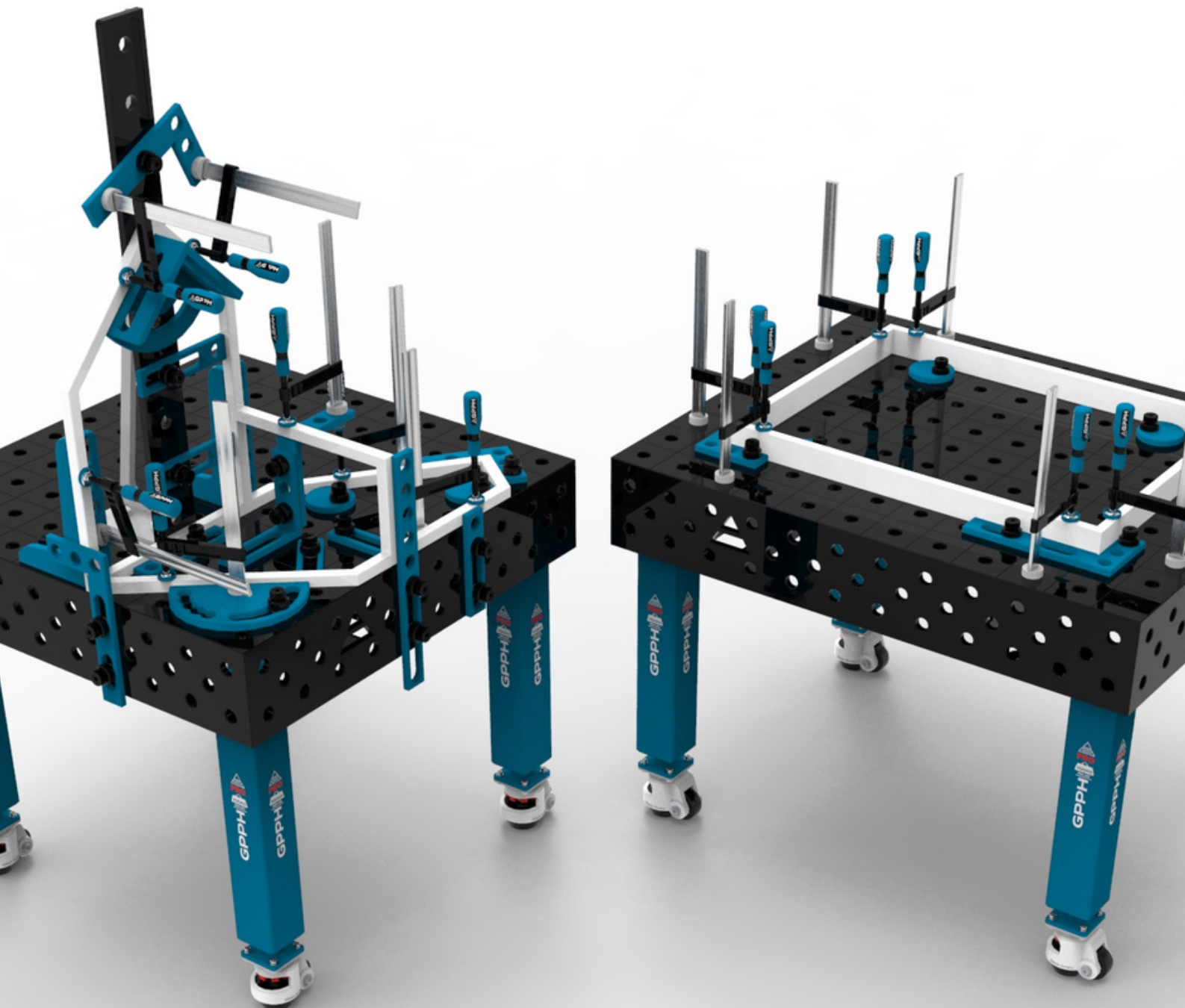

# TOOLKIT<sup>PRO</sup> NO. 1

Number of jigs & fixtures included in the kit: 146

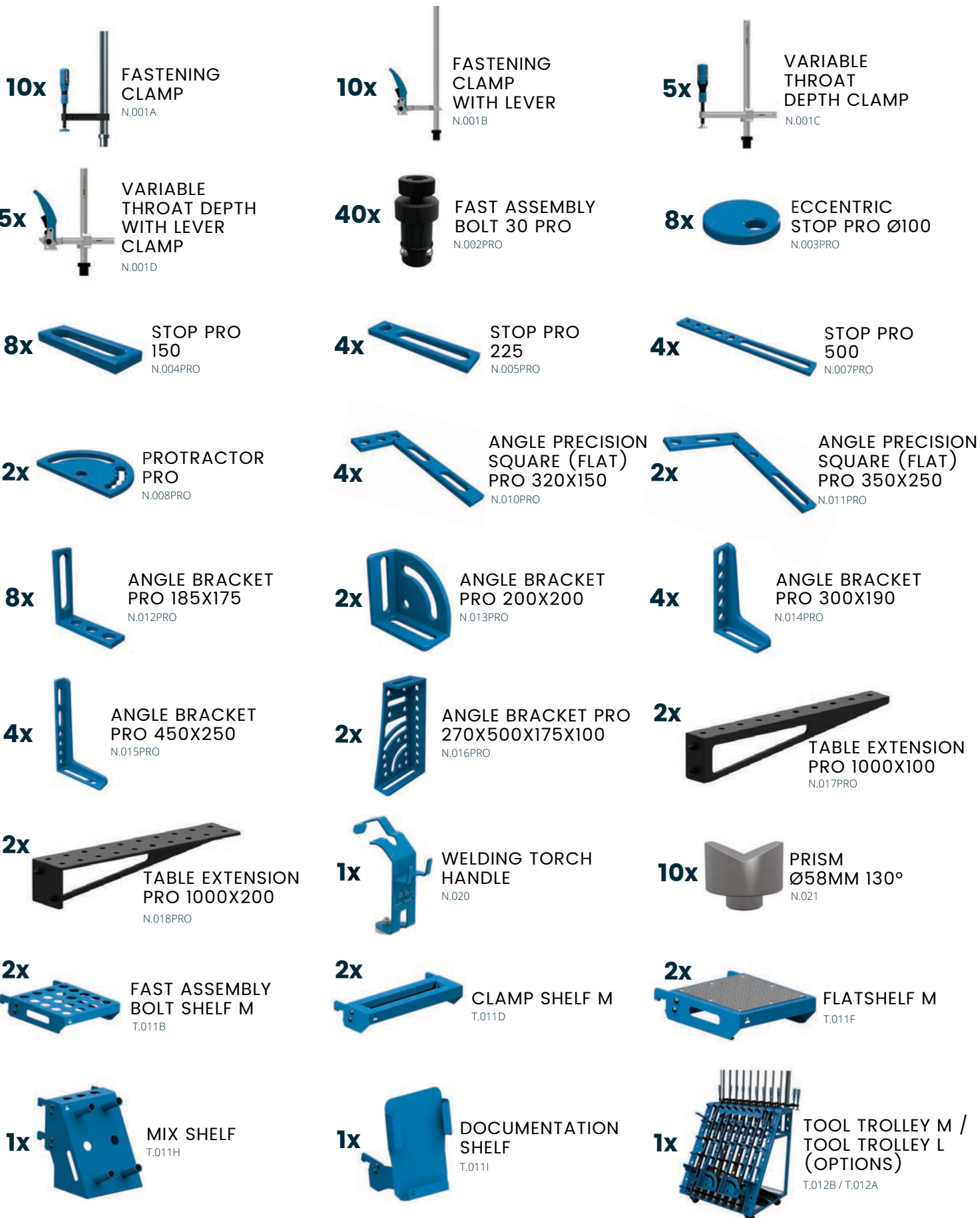



# TOOLKIT<sup>PRO</sup> NO. 2

Number of jigs & fixtures included in the kit: 96



8x

FASTENING  
CLAMP  
N.001A



4x

FASTENING  
CLAMP  
WITH LEVER  
N.001B



2x

VARIABLE  
THROAT  
DEPTH CLAMP  
N.001C



2x

VARIABLE  
THROAT DEPTH  
WITH LEVER  
CLAMP  
N.001D



30x

FAST ASSEMBLY  
BOLT 30 PRO  
N.002PRO



6x

ECCENTRIC  
STOP PRO Ø100  
N.003PRO



6x

STOP PRO  
150  
N.004PRO



4x

STOP PRO  
225  
N.005PRO



2x

STOP PRO  
500  
N.007PRO



1x

PROTRACTOR  
PRO  
N.008PRO



4x

ANGLE PRECISION  
SQUARE (FLAT)  
PRO 320X150  
N.010PRO



2x

ANGLE PRECISION  
SQUARE (FLAT)  
PRO 350X250  
N.011PRO



4x

ANGLE BRACKET  
PRO 185X175  
N.012PRO



2x

ANGLE BRACKET  
PRO 200X200  
N.013PRO



2x

ANGLE BRACKET  
PRO 300X190  
N.014PRO



2x

ANGLE BRACKET  
PRO 450X250  
N.015PRO



1x

TABLE EXTENSION  
PRO 1000X100  
N.017PRO



1x

TABLE EXTENSION  
PRO 1000X200  
N.018PRO



4x

PRISM Ø58MM  
130°/90°  
N.023



1x

WELDING TORCH  
HANDLE  
N.020



2x

FAST ASSEMBLY  
BOLT SHELF M  
T.011B



2x

CLAMP SHELF M  
T.011D

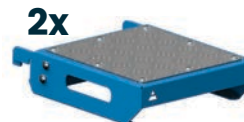

2x

FLATSHELF M  
T.011F



1x

MIX SHELF  
T.011H

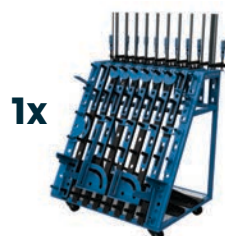

1x

TOOL TROLLEY M /  
TOOL TROLLEY L  
(OPTIONS)  
T.012B / T.012A

# TOOLKIT<sup>PRO</sup> NO. 3

Number of jigs & fixtures included in the kit: 60

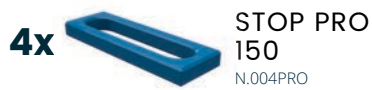

# TOOLKIT<sup>PRO</sup> NO. 4

Number of jigs & fixtures included in the kit: 28

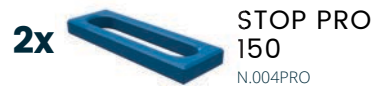

# TOOLKIT<sup>PLUS</sup> NO. 1

Number of jigs & fixtures included in the kit: 146



10x

FASTENING  
CLAMP  
N.001A



10x

FASTENING  
CLAMP  
WITH LEVER  
N.001B



5x

VARIABLE  
THROAT  
DEPTH CLAMP  
N.001C



5x

VARIABLE  
THROAT DEPTH  
WITH LEVER  
CLAMP  
N.001D



40x

FAST ASSEMBLY  
BOLT 23 PLUS  
N.002PLUS



8x

ECCENTRIC STOP  
PLUS Ø100  
N.003PLUS



8x

STOP PLUS  
150  
N.004PLUS



4x

STOP PLUS  
225  
N.005PLUS



4x

STOP PLUS  
500  
N.007PLUS



2x

PROTRACTOR  
PLUS  
N.008PLUS



4x

ANGLE PRECISION  
SQUARE (FLAT)  
PLUS 320X150  
N.010PLUS



2x

ANGLE PRECISION  
SQUARE (FLAT)  
PLUS 350X250  
N.011PLUS



8x

ANGLE BRACKET  
PLUS 185X175  
N.012PLUS



2x

ANGLE BRACKET  
PLUS 200X200  
N.013PLUS



4x

ANGLE BRACKET  
PLUS 300X190  
N.014PLUS



4x

ANGLE BRACKET  
PLUS 450X250  
N.015PLUS



2x

ANGLE BRACKET PLUS  
270X500X175X100  
N.016PLUS



2x

TABLE EXTENSION  
PLUS 1000X100  
N.017PLUS



2x

TABLE EXTENSION  
1000X200  
N.018PLUS



1x

WELDING TORCH  
HANDLE  
N.020



10x

PRISM  
Ø58MM 130°  
N.021



2x

FAST ASSEMBLY  
BOLT SHELF M  
T.011B

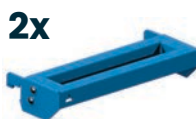

2x

CLAMP SHELF M  
T.011D

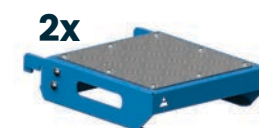

2x

FLATSHELF M  
T.011F



1x

MIX SHELF  
T.011H



1x

DOCUMENTATION  
SHELF  
T.011I

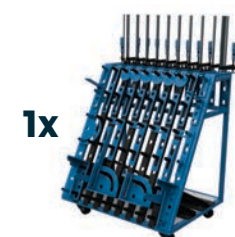

1x

TOOL TROLLEY M /  
TOOL TROLLEY L  
(OPTIONS)  
T.012B / T.012A

# TOOLKIT<sup>PLUS</sup> NO. 2

Number of jigs & fixtures included in the kit: 96



8x

FASTENING  
CLAMP  
N.001A



4x

FASTENING  
CLAMP  
WITH LEVER  
N.001B



2x

VARIABLE  
THROAT  
DEPTH CLAMP  
N.001C



2x

VARIABLE  
THROAT DEPTH  
WITH LEVER  
CLAMP  
N.001D



30x

FAST ASSEMBLY  
BOLT 23 PLUS  
N.002PLUS



6x

ECCENTRIC STOP  
PLUS Ø100  
N.003PLUS



6x

STOP PLUS  
150  
N.004PLUS



4x

STOP PLUS  
225  
N.005PLUS



2x

STOP PLUS  
500  
N.007PLUS



1x

PROTRACTOR  
PLUS  
N.008PLUS



4x

ANGLE PRECISION  
SQUARE (FLAT)  
PLUS 320X150  
N.010PLUS



2x

ANGLE PRECISION  
SQUARE (FLAT)  
PLUS 350X250  
N.011PLUS



4x

ANGLE BRACKET  
PLUS 185X175  
N.012PLUS



2x

ANGLE BRACKET  
PLUS 200X200  
N.013PLUS



2x

ANGLE BRACKET  
PLUS 300X190  
N.014PLUS



2x

ANGLE BRACKET  
PLUS 450X250  
N.015PLUS



1x

TABLE EXTENSION  
PLUS 1000X100  
N.017PLUS



1x

TABLE EXTENSION  
PLUS 1000X200  
N.018PLUS



4x

PRISM Ø58MM  
130°/90°  
N.023



1x

WELDING TORCH  
HANDLE  
N.020



2x

FAST ASSEMBLY  
BOLT SHELF M  
T.011B

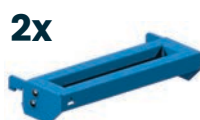

2x

CLAMP SHELF M  
T.011D

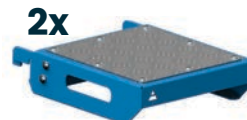

2x

FLATSHELF M  
T.011F



1x

MIX SHELF  
T.011H

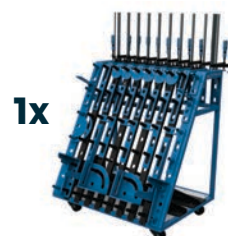

1x

TOOL TROLLEY M /  
TOOL TROLLEY L  
(OPTIONS)  
T.012B / T.012A

# TOOLKIT<sup>PLUS</sup> NO. 3

Number of jigs & fixtures included in the kit: 60



# TOOLKIT<sup>PLUS</sup> NO. 4

Number of jigs & fixtures included in the kit: 28



# ORDER DOES MATTER

## GPPH TOOL TROLLEY

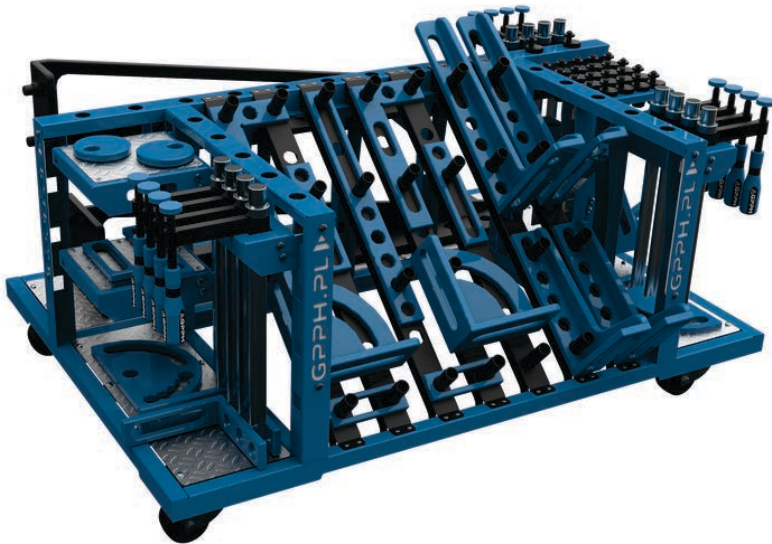

One of the many advantages of the small tool trolley is that it fits under most dimensions of GPPH Welding Tables. You have all the tools at your fingertips while working!

T.012B | Cat. No.

The large GPPH tool trolley will accommodate a set of tools even for the most demanding user! Thanks to it, your workplace will become transparent like never before, and GPPH tools will be clearly arranged and more accessible.

T.012A | Cat. No.





# THANK YOU FOR YOUR TIME SPENT ON ACQUAINTING WITH GPPH OFFER

WE HOPE FOR LONG-LASTING AND SUCCESSFUL  
COOPERATION.

IN CASE OF ANY QUESTIONS, I OFFER HELP  
AND EXPERTISE.

---

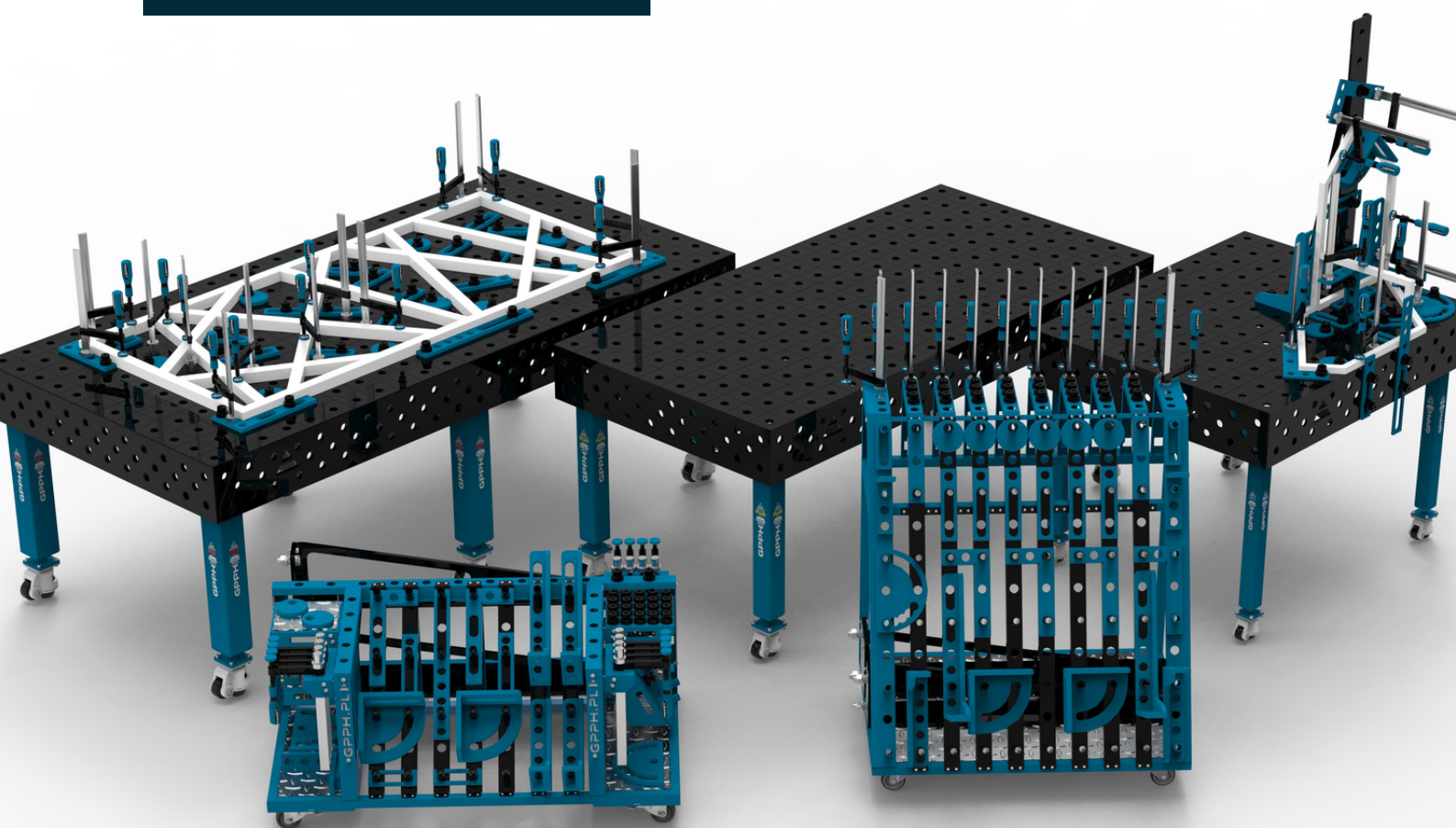

# #weldinglikeaPRO